



ITTF
BOD
WORKING
DOCUMENTS
19TH NOVEMBER 2020



INTERNATIONAL TABLE TENNIS FEDERATION

BOARD OF DIRECTORS MEETING

The Board of Directors Meeting of the International Table Tennis Federation will be held on virtually on Thursday 19th November 2020 at 11h00 CET.

AGENDA

1. President Welcome and Opening Address
2. Roll call, welcome and ratification of new members
3. Confirmation of the minutes of the BoD meeting held on 24th April 2019 in Budapest, Hungary
4. Annual reports from the Athletes Commission and the Commissioners
 - 4.1 Athletes' Commission
 - 4.2 Junior Commissioner
 - 4.3 Technical Commissioner
 - 4.4 Gender Commissioner
5. Future Events Working Group Report
6. Propositions and resolutions
7. Competition Updates
 - 7.1 World Championships Update
 - 7.2 World Cups Updates
 - 7.3 World Tour and Challenge Events Update
 - 7.4 Global Junior Program Update
 - 7.4.1 2020 World Junior Championships Update
 - 7.4.2 2021 and 2022 World Youth Championships
 - 7.4.3 Future World Youth Championships - deadlines
 - 7.5 World Veteran Championships update
 - 7.6 World Veterans Tour update
 - 7.7 Para Table Tennis Update
 - 7.7.1 2022 World Para Championships - deadlines
8. Future of Committees
9. Personal Honorary Membership recommendation
10. Next Board of Directors meeting
11. Any other business
12. Adjournment

CHAIR OF THE ATHLETES' COMMISSION (Zoran Primorac)

Report to the AGM and BoD

Document G1

Changes within the Athletes' Commission

Since the last Athletes' Commission (AC) report submitted at the World Championships in Budapest, AC had one change: Jasna Reed accepted a new position at the ITTF, so she was replaced by Alberto Mino, from Ecuador.

Our current Athletes' Commission is composed of:

- Chair - Zoran Primorac (CRO)
- Deputy Chairs - Galia Dvorak (ESP) and Dana Cechova (CZE)
- Para Athletes - Alena Kanova (SVK) and Trevor Hirth (AUS)
- Athletes - Sarah Hanffou (CMR), Alberto Mino (ECU), Wang Liqin (CHN), Jean-Michel Saive (BEL), Elsayed Lashin (EGY), Marcos Madrid (MEX) and Matthew Hetherington (NZL)
- IOC AC member - Ryu Seungmin (KOR)

Activities of the Athletes' Commission - overview of the Athletes' Commission activities within 2019:

EC Meetings:

- February 2019 in Bangkok, Thailand
- April 2019 in Budapest, Hungary
- October 2019 in Chengdu, China
- December 2019 in Zhengzhou, China

Players - ITTF leadership meeting was held in Doha, Qatar on 19th March 2019.

Various topics were discussed, including insufficient prize money, expensive accommodation costs, prize money distribution, 64 players draw for the Platinum and major World Tours events, insufficient table numbers in the practice halls and hot food in the players lounges.

IOC Athlete 365 program:

We didn't organise any workshops since the last AC annual report, and therefore it would be good to do so in the next period, for the well-being of the players.

The objective of the workshops is to promote dual career, which emphasises importance of professional athletes' education and/or building different skills while they are still active in the sport.

Since the ITTF has many trained Athlete 365 educators there is significant potential to organise a higher number of Athlete 365 workshops in the future, with athletes of different age groups.

We attended the 9th International Athletes Forum which was held in Lausanne on April 13-15, 2019. The key recommendations were:

- To strengthen athlete representation
- To strengthen direct financial support for NOC athletes' commissions (hopefully International Federations AC's will be included too!)
- To strengthen the support for career transition

- To strengthen the protection of clean athletes and fight against doping
- To focus on athletes' mental health

We hope that these recommendations and values can be implemented in the future of the ITTF strategic development.

ITTF Foundation:

Athletes Commission signed agreement with ITTF Foundation to create the Athletes Emergency Fund (AEF) to help players with emergency health situations (illnesses and/or accidents).

We strongly supported the idea and organisation of the first ITTF Parkinson's World Championships in Westchester, USA (October 2019). We think that through our sport we can promote health and other social values.

The new world ranking system:

We are happy that ITTF hired new World Ranking Manager, Javier Angulo, showing the importance of the World Rankings list. Also, adding one extra member from the AC to the World Ranking working group is providing an opportunity to develop a better ranking system for the benefit of the athletes.

When making changes, there needs to be considered timing, especially if it is too close to the Olympics. Any additional corrections and improvements should be done right after the 2020 Olympics, so that everyone has time to adapt to the new ranking system.

World Table Tennis

In communication with table tennis athletes, we have great expectations from the year 2021, when all commercial rights will be taken back in-house by the ITTF.

We see this as a great opportunity for our sport to make a great step forward in professionalism and commercialization, which will lead to increased prize money and better tournament conditions.

We are looking forward to future cooperation with all ITTF stakeholders in order to assure the progressive and sustainable future development of table tennis.

I would like to use this opportunity to thank my Athletes' Commission members for their commitment and engagement for the benefit of the table tennis as a sport, and most importantly its players.

Zoran Primorac

Chair of the Athletes' Commission

World Junior Circuit

The ITTF World Junior Circuit is an important series on the ITTF calendar. In 2019, 26 WJC events were organised across the world, in all continents, and divided into four golden, nine premium and 13 regular events.

Tournaments per continent from 2017 until 2019:

	2017	2018	2019	2018 --> 2019
Africa	2	3	3	0
Asia	5	6	6	0
Europe	14	13	14	1
Latin America	3	2	2	0
North America	0	1	0	-1
Oceania	1	1	1	0
Total	25	26	26	0

Total players in 2019 WJC events: 2,340 players (1,332 Boys and 1,008 Girls)

Player participation per continent from 2017 until 2019:

	2017	2018	2019	2018 --> 2019
Africa	150	182	189	7
Asia	557	702	673	-29
Europe	1156	1158	1205	47
Latin America	248	228	187	-41
North America	42	77	55	-22
Oceania	43	38	31	-7
Total	2196	2385	2340	-45

For the first time scholarships worth a total of US\$ 16,000 per gender will be awarded to the top eight players of each gender on the final 2019 ITTF Junior Circuit Points Standings (subject to a maximum of one player of each gender per association. I hope the scholarship will be well used.

In 2020 the number of events was increased from 26 events 2019 to a total of 33 events. Events were planned for all continents; this year the WJC series is divided into **five** golden, nine premium and **19** regular events.

World Cadet Challenge

The WCC 2019 in Wladislawowo, Poland, was a big success. Both the training camp and the competition itself were very well organised. Every team participating was very satisfied with the tournament and the training camp in advance.

In October 2020 the last edition of the WCC with the current system will take place in Thailand.

The future of the WCC from 2021 on will be decided this year.

World Junior Championships (WJTTC)

The WJTTC 2019 in Korat, Thailand, was very well organised, with very good conditions in a perfect venue. The presentation was also very good.

The format with 16 teams and 80 participants per gender was played for the second time this year and well accepted.

The ranking point system with the special seeding implementation caused many complaints by associations in 2018. Thanks to the very cooperative and good work of the small group including the junior events manager, the competition director for junior events and the Junior and Technical Commissioner, the problems regarding the ranking point system were solved. We had no complaints regarding the seeding/special seeding for the WJTTC.

Until now only the winners of the qualification groups in singles events advance to the main draw. We want to change this in order to give also the runner up of the qualifications groups a chance to advance to the main draw; that's the reason why we have a **proposition to the BoD** to change it for WJTTC 2020.

In 2021 the WJTTC will take place in Tunis, Tunisia.

The bids for the 2022 WJTTC are open, but we have no applicants so far. ITTF still welcomes bids from associations who would like to host the WJTTC 2022.

Finally, I thank everyone who is involved and engaged in the ITTF Junior Programme – a special thank you goes to Tiago Viegas for his great work as the junior events manager.

Thank you to all involved for your cooperation and good work. It was and is a pleasure to work together with you all.

Heike Ahlert

Junior Commissioner

TECHNICAL COMMISSIONER (Graeme Ireland)

Report to the BoD

Document G3

The mandate of the Technical Commissioner includes:

- Liaise with the Competition Department and advise the BoD on the organisation of World Title competitions and to make recommendations on the system of play;
- Assist the Competition Department and referee with the World Championships draws;
- Advise on the playing schedule for the World Title competitions, if necessary;
- Serve as a member of the Ranking Default Commission;
- Provide advice on eligibility matters
- Act as the Chair of the Jury at the World Championships;
- Provide technical assistance for Multi-Sport Games and Continental Championships;
- Work closely with the Competition Department to achieve the above objectives; and
- Provide technical expertise and guidance to the Equipment, Rules, Umpires and Referees Committees, PTT Division and professional staff.

The responsibilities are handled in close co-operation with the Competition Department.

In 2019 my main role was to assist the ITTF and the Competition Department on the playing format, schedules, and general inquiries relating to technical rules for all major events. It included the Olympic Games, World Cups, World Championships and World Junior Championships. I have also assisted as a member of working groups looking at various items, such as the new ranking system, service rule, the Olympic playing system and the Olympic qualification system. Also I have provided expertise and assistance as required to other committees, mainly to the URC, and the ITTF staff, whenever requested. I am also available to liaise with the continental representatives on technical issues related to continental events to align them more closely with ITTF events.

Graeme Ireland

Technical Commissioner

GENDER COMMISSIONER (Hajera Kajee)

Report to the BoD

Document G4

1. Fourth International Federation Gender Equality Forum

Katarzyna Kubas represented the ITTF at the Forum on 12th April 2019 in Lausanne, Switzerland. The Forum was organised by the International Olympic Committee in partnership with the Association of Summer Olympic International Federations and the Association of International Olympic Winter Sports Federations.

The objective for this year's edition was to present the status of gender equality in sport within the International Sports Federations and to share best practices on the implementation progress of the IOC Gender Equality Review Project.

The six main topics discussed during the Forum were governance, mechanisms to increase the pipeline of women for decision-making positions, funding allocations, coaches and technical officials at Olympic Games, tracking and monitoring progress and, last but not least, collaboration between International Federations, National Associations and National Olympic Committees.

2. Gender Equality International Federation (IF) Seminar

Katarzyna Kubas represented the ITTF at the Seminar on 10th September 2019 in Lausanne, Switzerland.

The agenda of the Seminar focused on: **'What are the best ways for IFs to promote and implement gender equality in their sports?'** where 25 actions (ideas & thoughts to takeaway and start using in the organisation) has been presented.

Five key topics was discussed during Seminar: commercial-value, participation-balance, empowerment, culture-events & portrayal-communication.

3. 2019 Women Development Programmes

Participation figures for all continents (as of 1st Jan 2020)

	2019	2018	2017	2016
Women	39% (1,294)	32% (392)	38% (1,492)	36% (1,756)
Men	61% (2,008)	68% (931)	62% (2,452)	64% (3,117)

There was a significant increase of female participation in 2019, once of the highest ever, mainly due to the new dedicated initiatives and incentives offered through the Continental Development Programme, like for instance the "My Gender. My Strength." project, bonuses for female participation etc.

4. ITTF Events Participation - Players

- a. Liebherr 2019 World Table Tennis Championships, 21-28 April 2019, Budapest (HUN)
Women 281 players 45% - Men 308 players 55%
- b. 2019 World Junior Table Tennis Championships, 24 Nov – 1 Dec 2019, Korat (THA)
Girls 16 teams 50% - Boys 16 teams 50%
Girls 80 players 50% - Boys 80 players 50%
- c. ITTF World Tours 2019
Women 370 players 42% - Men 509 players 58%
- d. ITTF World Junior Circuits 2019
Junior Girls 713 players 43% - Junior Boys 956 players 57%
Cadet Girls 561 players 44% - Cadet Boys 714 players 56%

5. ITTF World Championships – Umpires

- a. Liebherr 2019 World Table Tennis Championships, 21-28 April 2019, Budapest (HUN)
Women 12 umpires 33% - Men 24 umpires 55%
- b. 2019 World Junior Table Tennis Championships, 24 Nov – 1 Dec 2019, Korat (THA)
Women 9 umpires 45% - Men 11 umpires 55%

6. 2019 Women-Specific Development Programme Courses

Continent	Country	Date	Course Type
Africa	Djibouti	25-30 Dec 2019	Youth Training Camp
	Tunisia	16-22 Dec 2019	ITTF-PTT L1 CE + CCT
Asia	Jordan	Postponed to 2020	TBC
Europe	Slovakia	6-8 Jun 2019	Women's Coaching Seminar
Latin America	Peru	23 – 28 Nov 2019	ITTF-PTT Level 1 Coach Education Course + Forum
North America	USA	27 May – 2 Jun 2019	Women's Coaching Evaluation/Course during CHW&C
Oceania	Carry over to 2020	TBC	TBC

7. “My Gender. My Strength.” Programme - National Association Assistance Programme for Women's Development in Table Tennis

The aim of this initiative is to, enhance and advance women's participation in table tennis by supporting national projects designed for female players, coaches, match officials, administrators or managers.

In 2019, the Programme was implemented under the 2019 Asia and Latin America Development Programme respectively. The national associations took ownership of the project in order to meet the needs and desired outcomes.

The ITTF received 16 applications in total, including nine applications from Latin America and seven from Asia but only five successful projects per continent have been selected. They were presented by Ecuador, Guatemala, Nicaragua, Suriname and Venezuela from Latin America and Afghanistan, Mongolia, Lebanon, Sri Lanka and Uzbekistan from Asia.

The ITTF contribution of US\$1,000 was designed for each selected project, for its implementation.

In conclusion, “My Gender. My Strength.” Programme had 192 participants in total in Latin America, 165 of whom were women, and 269 participants in total in Asia with 254 of women.

8. 2019 ITTF Success Stories

WSLA – Women's Sports Leadership Academy

Online application's process was launched by the ITTF a total of twenty-one (21) women applied for the 7th Annual Residential Week at the University of Chichester in the United Kingdom to be held 15-19 June 2020.

Three women have been selected, two (2) from the Olympic Movement, one (1) from the Paralympic Movement their application has been entered, we await the final decision of WSLA, the IITF will fund the three (3) participants viz.

- ✓ **Abeba Amare Ante** currently General Secretary of Ethiopian Table Tennis Federation
- ✓ **Haleena Kakar** currently acting President and General Secretary of Afghanistan Table Tennis Federation.
- ✓ **Audrey Le Morvan** currently working at the French Disabled Sports Federation.

ITTF Foundation commenced an **Inspirational Women's Series** An online campaign that supports & advocates for women participation & empowerment in sport and sport for development and peace.

9. Additional Information

- a. **The 2019 Mentorship Program** expanded to 5 projects in 2019 targeting four coaches, with one being specific to PTT (Para Table Tennis), and one match official to be selected as mentees from the applications. Out of these five, two slots (40%) were dedicated to Women's candidates.
- b. **2019 World Hopes Week and Challenge - Wild Cards** - Three players per gender had an opportunity to take a spot at the 2019 ITTF World Hopes Week and Challenge in Salalah, Oman from 25th to 31st July 2019 through "Wild Card" allocations, making it an equal division between genders.
- c. **HP Hopes Program** - An equal number of girls and boys are invited to participate at the World Hopes and the later selections with encouragement being given to participation of female coaches to accompany girls. The 2018 Hopes Ambassador was female, Bruna Takahashi of BRA.
- d. **ITTF Training Camps for U15, U18 and U21** - At the High-Performance Training Camps, an equal number of invitations is issued to players of both genders, with the aim of having a balanced number of female and male players in attendance. Hospitality support is granted to a NA if one coach, out of two coaches is a female.
- e. **2019 With the Future in Mind Scholarships Program.** This Program is run in co-operation with Olympic Solidarity and refers to 2019 scholarships considering players for the 2020 Tokyo & 2022 Dakar, ensuring **Equal** number of girls and boys are nominated.

10. Conclusion

My appreciation and thanks to the President Mr. Thomas Weikert, the ITTF Executive Committee Members, and the Continental Presidents for their commitment to the promotion of Gender Equality.

A special thanks to the ITTF Chief Executive Officer Mr. Steve Dainton, the Directors, and the ITTF staff for their support.

Hajera Kajee (Ms)
Gender Commissioner

Propositions to the 2020 ITTF BoD

Proposition 18

(Simple majority required)

Proposed by the ITTF Executive Committee.

To amend 3.2.3.4:

3.2.3.4 In World, Olympic and Paralympic title competitions the light intensity, measured at the height of the playing surface, shall be at least **1500** ~~1000~~ lux uniformly over the whole of the playing surface and at least **1000** ~~1000~~ lux elsewhere in the playing area; in other competitions the intensity shall be at least **1000** ~~600~~ lux uniformly over the playing surface and at least **600** ~~400~~ lux elsewhere in the playing area..

Rationale:

Update to bring the ITTF Handbook in line with current requirements.

Proposition 19

(Simple majority required)

Proposed by the ITTF Executive Committee.

3.2.4.2 A racket control centre shall be established at all ITTF World Title, Olympic and Paralympic competitions as well as at a select number of **other** ITTF ~~World Tour and Junior Circuit~~ competitions and may be established at Continental and Regional competitions.

Rationale:

To cover all event categories and eliminate the need of updating event names in case there is a change.

Propositions to the 2020 ITTF BoD

Proposition 20

(Simple majority required)

Proposed by the ITTF Rules Committee.

3.2.5.7 There may be 2 temporary advertisements on nets on each side of the table which shall be clearly different from the colour of the ball in use, shall not be within 3cm of the tape along the top edge; advertisements placed on parts of the net within the vertical extensions of the side lines of the table shall be a logo, wordmark or other icons ~~in a single dark colour~~.

If this deletion is passed the new 3.2.5.7 could be shortened to:

3.2.5.7 There may be 2 temporary advertisements on nets on each side of the table which shall be a logo, wordmark or other icons, shall be clearly different from the colour of the ball in use and shall not be within 3cm of the tape along the top edge.

Rationale:

It was repeatedly suggested to accept any colours being clearly different from the colour of the ball in use also for advertisements placed on parts of the net within the vertical extensions of the side lines of the table.

At the same time, it should be made clear that such advertisements are temporary ones.

Propositions to the 2020 ITTF BoD

Proposition 21

(Simple majority required)

Proposed by the ITTF Executive Committee.

To amend 3.5.1.2, 3.6 and 3.6.3.4:

3.5.1.2 In an individual event, a player or pair may receive advice only from one person, designated beforehand to the umpire, except that where the players of a doubles pair are from different Associations each may designate an adviser, but with regard to 3.5.1 and 3.5.2 these two **advisers** ~~advisors~~ shall be treated as a unit; if an unauthorised person gives advice the umpire shall hold up a red card and send him or her away from the playing area.

..//..

3.6 DRAW FOR **KNOCKOUT** ~~KNOCK-OUT~~ COMPETITIONS

..//..

3.6.3.4 Remaining entries shall be separated only in groups and in the first round of the qualification draw for **knockouts** ~~knock-outs~~ and the main draw, but not in further rounds.

Rationale:

Simple grammatical corrections.

Proposition 22

(Simple majority required)

Proposed by the ITTF Executive Committee.

3.7.4.2 In world title competitions, players **in youth**, ~~junior and cadet~~ **events** must be ~~under 24~~, under ~~19~~ **8** and under 15 ~~respectively~~ in age on 31st December immediately before the calendar year in which the competition takes place.; ~~these~~ **The following** age limits are recommended for corresponding events in other **youth** competitions: **U21, U19, U17, U15, U13, U11.**

Rationale:

- *To adjust the new age categories in line with the new events structures.*
 - *To increase the inter-generation competitiveness and make participation at events more meaningful.*
 - *Opportunities for talented and/or faster improving players to check their skills with slightly older peers.*
-

Propositions to the 2020 ITTF BoD

Proposition 23

(Simple majority required)

Proposed by the ITTF Executive Committee.

3.7.6.4 Best of 7 matches (6 singles and 1 doubles)

3.7.6.4.1 A team shall consist of 3, 4 or 5 players.

3.7.6.4.2 The order of play shall be

1) A v ~~Y~~ X

2) B v ~~X~~ Y

3) C v Z

4) doubles

5) A v ~~X~~ Y

6) C v ~~Y~~ X

7) B v Z

Rationale:

The 7-match team format (3.7.6.4) is the only team format where the order of play of both teams in the first round of matches does not match the alphabetical order of the player designations. Consequently, sometimes confusion is created with teams using XYZ expecting that X will play the first match etc.

Proposition 24

(Simple majority required)

Proposed by the ITTF Executive Committee.

To amend chapter 4. (See annex 1)

Rationale:

All changes are reflecting updates to align with the new WTTC, to clean up duplications (i.e. Doping already covered in the ITTF Handbook), to keep operational procedures covered by the event manuals produced by ITTF out of the ITTF Handbook and to align details to be in line with current practices.

Propositions to the 2020 ITTF BoD

Proposition 25

(Simple majority required)

Proposed by the European Table Tennis Union.

Options for the new format of World Championships

5. In addition to the current eligibility rules, **an Association's** players and teams are eligible to participate in each stage, provided that **their Association** ~~they have participated~~ **has entered players and teams** in the earlier stages. The only non-mandatory event is that of the Regional Stage and according to each continent.

Rationale:

The current regulation agreed by the Board of Directors at Budapest 2019 restricts those players prevented by injury, illness, pregnancy or other personal reasons from participating in a later stage.

We do not consider this to be fair, appropriate or sporting. It may prevent the best players from participating.

In the best interests of athletes and our sport, we wish to ensure the best players (for example Hugo Calderano, Quadri Aruna, Sofia Polcanova, Bernadette Szocs, Petrissa Solja, Adriana Diaz, Dina Meshref) participate in the Finals, respecting all dedicated players at international level.

Our proposed wording will ensure all players may have the opportunity to qualify for and participate in the Finals.

Propositions to the 2020 ITTF BoD

Proposition 26

(Simple majority required)

Proposed by the European Table Tennis Union.

Options for the new format of World Championships

8. Finals

8.6.

~~Players/pairs qualifying for the Finals are individually qualified and their places cannot be reallocated to other players of the same association, unless the next eligible player/pair is from the same association.~~

Players/pairs qualifying for the Finals are not individually qualified but gain places for their Association which has the right to nominate according to the qualified number of places for the Finals.

If an Association nominates a player/pair who did not gain the place for their Association, the player must have a World Ranking 256* or better at the fixed deadline. If the Association is not able to comply, the vacant place will go to the highest ranked player/pair not yet qualified from another Association.

* for players that have been injured or pregnant and have no ranking or a low ranking the WR Seeding protection procedure shall be used to determine their ranking. Continental quota places shall always stay by the Continent.

Rationale:

Existing text of 8.6. conflicts with the logical consequences of 5.

By giving the right to Associations to choose the players we ensure the best players will be able to participate in the Finals.

We ensure qualified players will not be replaced by much lower ranked players but quota places should always stay in the Continent.

Propositions to the 2020 ITTF BoD

Proposition 27

(Simple majority required)

Proposed by the European Table Tennis Union.

Options for the new format of World Championships

7.2. Inter-Continental stage places (Africa: 1, Asia: 5 3, Europe: 3 5, Latin America: 1, North America: 1, Oceania: 1)

Rationale:

The text agreed by the Board of Directors at Budapest 2019 included a typographical error which we kindly request is corrected.

The summary notes of the Future Events working group (FEWG) meeting at Singapore on 30th/31st August 2019 record that there is a discrepancy.

The minutes of the FEWG meeting at Alicante on 17th/18th September 2018 record on page 11 the proposed Inter-Continental stage allocations, Asia 3 and Europe 5.

The Deloitte Key Findings draft report dated 20th March 2019 states on pages 17, 25, 26 and 31 that the proposed Inter-Continental stage allocations are Asia 3 and Europe 5.

Propositions to the 2020 ITTF BoD

Proposition 28

(Simple majority required)

Proposed by the Hong Kong Table Tennis Association.

Following the decision of the ITTF Board of Directors at Budapest regarding the future World Team Table Tennis Championships format for the system of play in the final stage of WTTTC with 8 groups of 4 teams, we request the ITTF Board of Directors to:

1. Increase the number of teams for the World Table Tennis Championships Finals to be held in Chengdu, China in 2022 from 32 to 40.
2. The 1st stage (Regional) to remain the same as planned
3. Directly qualify 34 teams from the 2nd stage (Continental) including the host Association
4. With the increase number 8 teams from the 2nd stage, the distribution of quota would be 4 for Africa, 10 for Asia, 11 for Europe, 4 for Latin America, 2 for North America and 2 for Oceania.
5. Directly qualify 6 teams from the 3rd stage (Intercontinental),
6. The Finals will be played in 8 groups of 5 teams (same number of groups).

The method of play for the Regional, Continental Stage and Inter-Continental stages would basically be the same, only with the increased quota for the Continental Stage with at least one slot for each continent plus one more slot to Asia & Europe.

Rationale:

1. For the vast majority of ITTF Member Associations team events are crucial. Adding 8 teams would allow a wider representation from all continents at the World Team Championships Finals as previously agreed.

2. With the moderate increase of total number of teams from 32 to 40, it will also provide more motivation for some weaker/growing teams in each continent to promote table tennis in their countries, particularly when the minimum quota for each continent is at least two (2).

Propositions to the 2020 ITTF BoD

Proposition 29

(Simple majority required)

Proposed by the Equipment Committee.

Amendment of Technical Leaflet T2 – The Net Assembly. (See annex 2)

Proposition 30

(Simple majority required)

Proposed by the Equipment Committee.

Amendment of Technical Leaflet T3 – The Ball. (See annex 3)

Proposition 31

(Simple majority required)

Proposed by the Equipment Committee.

Amendment of Technical Leaflet T4 – Racket Coverings. (See annex 4)

Proposition 32

(Simple majority required)

Proposed by the Equipment Committee.

Proposition for Colours in T4. (See annex 5)

4 REGULATIONS FOR WORLD, OLYMPIC AND PARALYMPIC TITLE COMPETITIONS

Rationale:

All changes are reflecting updates to:

- align with the new World Championships;
- align with the new World Youth Championships.
- to clean up duplications (i.e. Doping already covered in the handbook, entry and other processes covered in event specific documents and the prospectuses);
- to keep operational procedures out of the handbook and reflect them in the event manuals and other documents produced by ITTF.
- align other details to be in line with current practices.

4.1 WORLD CHAMPIONSHIPS

4.1.1 Authority for Organisation

4.1.1.1 The ~~title term~~ "World Championships", refers to all the stages of the World Championships; regional, continental, inter-continental and finals. ~~referred to in this Section as "Championships", shall be bestowed by the AGM on the championship events at a tournament organised by an Association entrusted with the task.~~

4.1.1.2 The closing date for applications to stage Championships shall be specified by the Executive Committee and notified to all Associations, giving at least 6 months' notice.

4.1.1.3 All applications ~~for the Championships Finals~~ shall be considered by the Executive Committee ~~and a short list~~ shall be submitted to the AGM, together with the report of the Selection Committee, if applicable. ~~on venues for the occasion in question.~~

4.1.1.4 Where necessary, the AGM or the Executive Committee may ask one or more members of the appropriate Committee to visit the country of an Association applying for the right to organise the Championships to satisfy themselves as to the adequacy of the proposed playing and other arrangements; the cost of such visits shall be borne by that Association.

4.1.1.5 If, after an option has been granted, circumstances change in such a way as to be likely to prejudice the satisfactory conduct of the Championships ~~Finals~~, the option may be revoked by a 2/3 majority vote at an AGM prior to the Championships; between AGMs the Board of Directors shall have power to transfer the Championships ~~Finals~~ or to take any other appropriate action.

4.1.2 Responsibilities of Organisers

4.1.2.1 An Association granted the right to organise **any stage of** the Championships, hereafter referred to as the "organisers" shall be responsible for conducting them in accordance with the Laws of Table Tennis, the Regulations for International Competitions and the Regulations for World Title Competitions, as modified or supplemented by any directives authorised by the Board of Directors **and the Event Manuals (Event Directives and Requirements) as developed by the ITTF.**

~~4.1.2.2 Organisers shall provide accommodation and meals from lunch on the day before the Championships begin until breakfast on the day after the Championships end for:~~

~~4.1.2.2.1 not more than 2 men and 2 women players nominated by an Association;~~

~~4.1.2.2.2 1 delegate to the AGM from each Association if he is not already included in the nominated players listed above;~~

~~4.1.2.2.3 members of the Executive Committee, the Board of Directors and the Olympic and Paralympic Commission, full members of committees and the Technical and Gender Commissioners;~~

~~4.1.2.2.4 up to 3 Doping Control Supervisors appointed by the Sports Science and Medical Committee;~~

~~4.1.2.2.5 members of the Athletes' Commission not already included in the nominated players' lists;~~

~~4.1.2.2.6 Honorary Presidents;~~

~~4.1.2.2.7 Personal Honorary Members;~~

~~4.1.2.2.8 members of the President's Advisory Council;~~

~~4.1.2.2.9 International Umpires, Referees and Evaluators from other Associations invited in accordance with the ITTF directives for match officials at World Title Competitions;~~

~~4.1.2.2.10 up to 7 members of the ITTF staff including 1 assisting the Doping Control Supervisors.~~

~~4.1.2.3 If the business of the ITTF extends outside the period of the Championships the period of hospitality for those entitled to participate in such business shall be extended correspondingly.~~

~~4.1.2.4 Organisers shall provide free medical care and medicine for all participants, but each Association is recommended to insure its players and officials against illness and injury for the duration of the Championships.~~

~~4.1.2.5 Organisers shall meet the cost of transport between the place of accommodation and the playing hall.~~

- ~~4.1.2.6 — Organisers shall request their national authorities to waive visa charges for all participants.~~
- ~~4.1.2.7 — Organisers shall ensure free access to the playing hall and free circulation therein for all the players, officials and members listed in 4.1.2.2, for any additional players and committee members and for any interpreter, doctor or medical adviser appointed by the ITTF.~~
- ~~4.1.2.8 — Organisers shall provide first-class interpreting in at least four languages, preferably by simultaneous translation with the appropriate equipment.~~
- ~~4.1.2.9 — Organisers shall provide the ITTF with offices at the venue of the Championships and place at its disposal translation, computer, internet, telephone, telefax and duplicating facilities.~~
- ~~4.1.2.10 — Organisers shall publish a prospectus giving the main details of the organisation of the Championships, including:~~
- ~~4.1.2.10.1 — the dates and place of the Championships;~~
 - ~~4.1.2.10.2 — the events to be held;~~
 - ~~4.1.2.10.3 — the equipment to be used;~~
 - ~~4.1.2.10.4 — the procedure for entry, the entry fees and the undertakings required;~~
 - ~~4.1.2.10.5 — the date and place of the draw;~~
 - ~~4.1.2.10.6 — the dates of Jury meetings and of AGM sessions;~~
 - ~~4.1.2.10.7 — the extent of hospitality for players and officials;~~
 - ~~4.1.2.10.8 — any directives authorised by the Board of Directors for the Championships.~~
- ~~4.1.2.11 — During the Championships Organisers shall make available promptly to members of the ITTF Executive Committee, Board of Directors members and team captain's details of results, including points scores; as soon as possible after the completion of the Championships Organisers shall publish the complete results, including points scores, and circulate them to all Associations.~~

4.1.3 Eligibility

- 4.1.3.1 Only an Association which is not in arrears (1.7.3.3) and has taken part ~~with at least one player or team (an entry)~~ in its preceding Continental Championships, including qualification tournaments, ~~or Continental Games~~, shall be eligible to ~~enter~~ **qualify** teams or individual players in the Championships **Finals**.
- 4.1.3.2 In addition to provisions of 3.8, players who have acquired a new nationality and wish to represent the ~~a~~ **A**ssociation corresponding to the new nationality shall register with ITTF through this new Association. A player is considered as registered either from the date of ITTF player registration confirmation or from the date the player is granted his or her new nationality, whichever is earlier.
- 4.1.3.3 Such player shall not represent the new Association before:

- 4.1.3.3.1 3 years after the date of registration, if the player is under the age of 15 when registered, but only 1 year after the date of registration if the player has never represented another Association;
- 4.1.3.3.2 5 years after the date of registration, if the player is under the age of 18 but at least 15 years of age when registered;
- 4.1.3.3.3 7 years after the date of registration, if the player is under the age of 21 but at least 18 years of age when registered.
- 4.1.3.3.4 9 years after the date of registration, if the player is at least 21 years old when registered.
- 4.1.3.4 A player having participated already in World Championships shall retain his or her eligibility.

4.1.3.5. The eligibility regulations apply to all stages of the World Championships; regional, continental, inter-continental and finals.

Exceptionally, if the regional or continental stages have their own eligibility requirements, these may continue in force only until before the 2023 World Championships start, but players not fulfilling the Championships eligibility will not be eligible to continue to the following stages (inter-continental and finals).

4.1.4 — Entry Fees and Levy

- ~~4.1.4.1 The entry fees shall be US\$100 for each entry in a team event, US\$50 for each pair in a doubles event and US\$25 for each entry in a singles event.~~
- ~~4.1.4.2 The entry fees shall be paid to the organisers at the time of entry and shall be shared equally between the organisers and the ITTF.~~
- ~~4.1.4.3 Fees for entries from an Association are due from that Association and shall always be payable, except that the Board of Directors may waive the fees where an Association is prevented from participating in the Championships by circumstances outside its control.~~

4.1.5 — Submission of Entries

- ~~4.1.5.1 The intention to enter teams or players shall be notified to the ITTF in a preliminary notification form provided by the Secretariat; the closing date for the receipt of this form shall be not later than 4 calendar months before the start of the Championships.~~
- ~~4.1.5.2 Information shall be distributed, together with the prospectus, by the Competition Department and entries shall be submitted as required.~~
- ~~4.1.5.3 The closing date for the final entries shall be not later than 2 calendar months before the start of the Championships.~~

~~4.1.5.4 — An Association may nominate up to 5 players and a non-playing captain for a team event; if a non-playing captain is not appointed one of the team players shall be designated as captain.~~

~~4.1.5.5 — An Association shall rank its nominated players and pairs in order of playing strength, which shall be consistent with their current world ranking.~~

~~4.1.5.6 — The ITTF may accept only formal nominations by an eligible Association, which are received, properly signed by a responsible representative of the nominating Association, on or before the closing date.~~

~~4.1.6 — Modification of Entries~~

~~4.1.6.1 — Modified entries shall be accepted, if notified by a representative of the nominating Association, at any time up to the day before the first official draw at World Championships (for individual events).~~

~~4.1.6.2 — Change the composition of a team may be accepted if notified by a representative of the nominating Association up to the time of the Jury meeting preceding the World Team Championships; no further changes will be accepted after this deadline.~~

~~4.1.6.3 — As soon as he or she arrives at the Championships venue, the representative of an Association requesting a change to the draw in consequence of any error or absence shall notify the referee or his or her deputy, or confirm any change already notified, on a form provided for the purpose.~~

~~4.1.6.4 — A request for modification of an entry cannot be considered unless it is made or confirmed by the representative of an Association immediately on arrival, other than a request based on the subsequent absence, illness or injury of one player of a doubles pair, which shall be made as soon as the contingency arises.~~

~~4.1.6.5 — All alterations that are authorised shall be notified immediately to team captains and, where appropriate, to Association representatives.~~

~~4.1.7 — Entry Obligations~~

~~4.1.7.1 — The entry form shall contain a statement, to be signed by a responsible representative of the nominating Association on behalf of all its nominated players and captains, that they understand and accept the conditions of the Championships and that they are prepared to compete against all other teams and individuals participating; no entry shall be valid unless accompanied by this declaration.~~

~~4.1.7.2 — In individual events all entrants are accepted as individual competitors; they shall be bound to do their utmost to win the events for which they are entered, irrespective of whether other entrants from the same Association have been~~

~~accepted to take part, and they shall not withdraw except for reasons of illness or injury.~~

~~4.1.8~~ **Jury**

~~4.1.8.1 The Jury shall consist of the Technical Commissioner, Chairs of the Technical, Rules and the Umpires' and Referees' Committees, a representative of the Competition Department, a representative of the organising committee and the referee; the referee shall have the right to speak but not to vote.~~

~~4.1.8.2 If any of the nominated Chairs is unable to attend a meeting of the Jury he or she may nominate to attend in his or her place another member of his or her Committee, who shall have the right to speak and to vote.~~

~~4.1.8.3 The Chair of the Jury shall be appointed by the members of the Jury.~~

~~4.1.8.4 Any Association directly affected by a matter under consideration at a Jury meeting shall be entitled to be represented at that meeting but shall not be entitled to vote.~~

~~4.1.8.5 The Jury shall have power to decide any question of appeal within the jurisdiction of a tournament management committee and to authorise team changes.~~

~~4.1.8.6 The Jury shall meet before the start of the Championships to be informed of all draw alterations requested up to that time and to decide any requests for changes in the composition of teams; any subsequent questions of draw alteration shall be decided by the Technical Commissioner in conjunction with a representative of the Competition Department and the Jury shall meet again only when convened by the Chair to consider appeals against its administrative decisions or decisions of the referee.~~

4.1.9 Events

4.1.9.1 In even numbered years, the Championships **Finals** shall include men's team and women's team events; while in odd numbered years the Championships **Finals** shall include men's singles, women's singles, men's doubles, women's doubles and mixed doubles events.

4.1.9.2 In doubles events, both players may be from different Associations.

4.1.9.3 The system of play in team and individual events, the system of qualification in the team event and their implementation dates shall be decided by the Board of Directors, on the recommendation of the Technical Commissioner and the Competition **Program Department**.

~~4.1.9.4 Team matches shall be the best of 5 singles, as provided in 3.7.6.1.~~

- 4.1.9.5 There shall not be more than 128 places in the first round ~~proper~~ of a singles and not more than 64 places in the first round ~~proper~~ of a men's, women's and mixed doubles event, unless otherwise authorised by the Executive Committee.
- 4.1.9.6 Each Association shall be entitled to ~~enter~~ **qualify maximum** 3 men and 3 women players in each singles event, with one additional player ranked in the top 100 and one additional player ranked in the top 20 of the ITTF world ranking list issued in January of the year of the Championships to a maximum of 5 men and 5 women. The maximum entry for each ~~a~~ Association is 4 players for men's doubles, 4 players for women's doubles and 2 men and 2 women for mixed doubles; all players may be different, however, each ~~a~~ Association can only enter a maximum of 2 combined pairs (players from different ~~a~~ Associations) per doubles event.
- 4.1.9.6.1 The host Association may enter up to ~~6~~ **3** men and ~~6~~ **3** women in each singles event, ~~3~~ **4** players for men's doubles, ~~3~~ **4** players for women's doubles and ~~3~~ **2** men and 2 women for mixed doubles regardless of ranking. **For Singles if by ranking they are entitled for additional 1 or 2 players then 4.1.9.6 applies.**
- 4.1.9.7 Players of the same Association shall be separated ~~according to 3.6.3.1 and 3.6.3.3,~~ only in ~~preliminary rounds and groups and in~~ the first round of the draw but not in further rounds.

~~4.1.10~~ — **Default**

- ~~4.1.10.1~~ — ~~An Association whose team is entered in the draw but which fails to compete in the event without adequate justification may be subject to disciplinary action by the AGM.~~
- ~~4.1.10.2~~ — ~~A team may begin, continue and complete a team match only with the full complement of players specified for the event, except that the referee may, at his or her discretion, allow a team to play with one player absent or an individual match to be omitted from the sequence where he or she is satisfied that the absence is due to accident, illness, injury or other circumstances outside the control of the player or the Association concerned, including disqualification by the referee in accordance with his or her authority.~~
- ~~4.1.10.3~~ — ~~An Association whose team begins to play in the event but which fails to complete its schedule of matches shall be liable to forfeit its entitlement to hospitality for its representatives at the Championships; an appeal against forfeit may be made to the Jury, whose decision shall be final.~~

~~4.1.11~~ — **Doping Control**

- ~~4.1.11.1~~ — ~~Doping control shall be carried out in accordance with ITTF Anti-Doping rules (Chapter 5).~~

~~4.1.12 Awards and Presentations~~

~~4.1.12.1 The permanent Championship trophies shall be:~~

~~4.1.12.1.1 the Swaythling Cup for the men's team event;~~

~~4.1.12.1.2 the Marcel Corbillon Cup for the women's team event;~~

~~4.1.12.1.3 the St Bride Vase for the men's singles event;~~

~~4.1.12.1.4 the G Geist Prize for the women's singles event;~~

~~4.1.12.1.5 the Iran Cup for the men's doubles event;~~

~~4.1.12.1.6 the W J Pope Trophy for the women's doubles event;~~

~~4.1.12.1.7 the Heydusek prize for the mixed doubles event.~~

~~4.1.12.2 The Association whose team wins a team event, and the winner of an individual event, shall be entitled to hold the appropriate trophy until 31st December in the year following that in which it is won; the pair winning a doubles event shall agree or decide by lot the order in which each of them shall hold the trophy for half of the specified period.~~

~~4.1.12.3 A player who wins the men's or women's singles event 3 times in succession or 4 times in all shall receive from the ITTF a half-size replica of the appropriate trophy as a permanent possession.~~

~~4.1.12.4 In both team and individual events the winners shall receive gold medals, the losing finalists silver medals and the losing semi-finalists bronze medals.~~

~~4.1.12.5 At presentation ceremonies for both team and individual events the national flags of the gold, silver and bronze medal winners shall be raised and the national anthem of the gold medal winner shall be played.~~

~~4.1.12.6 The Association whose team or player wins a trophy shall acknowledge its receipt in writing and at the end of the specified period shall deliver it, within 14 days of a formal notification by the Secretariat, at an agreed time and to an agreed place.~~

~~4.1.12.7 The Association acknowledging receipt of a trophy shall be responsible for its safe keeping including the arrangement of insurance. The cost of insurance and of inscription of winners' names, which in team events should include any non-playing captain, shall be borne by the Association whose team or players wins a trophy.~~

~~4.1.12.8 If a trophy is lost while in the possession of an Association, that Association shall be responsible for the provision of a similar replacement.~~

~~4.1.12.9 At the closing ceremony the Egypt Cup, the symbol of the friendship of the Championships, shall be handed over to a representative of the city in which the next Championships will take place; this city shall hold the Egypt Cup until the next Championships.~~

4.1.13—Commercial Rights

~~4.1.13.1 The ITTF exclusively owns and controls all commercial rights in and to the Championships. Such Commercial Rights to include, without limitation and in each case on a worldwide basis, all:~~

~~4.1.13.1.1 audio, visual and audio-visual and data rights (in every medium, whether or not existing as at the date of these regulations);~~

~~4.1.13.1.2 sponsorship, advertising, merchandising, marketing and other forms of rights of association;~~

~~4.1.13.1.3 ticketing, hospitality and other concession rights; and~~

~~4.1.13.1.4 other rights to commercialise the Championships (including without limitation any so-called "event rights" and any right to authorise the taking of bets on the Championships.~~

~~4.1.13.2 The ITTF shall be entitled to exploit the Commercial Rights in such manner as it considers appropriate, including granting licences in respect of the same (or part thereof) to the relevant Association or to other third party(ies) from time to time.~~

~~4.1.13.3 Each Association shall ensure that their members (officials, players, delegates and other affiliates) shall:~~

~~4.1.13.3.1 comply with any and all rules, regulations and/or guidelines in relation to the exploitation of the Commercial Rights which may be issued from time to time by or on behalf of the ITTF; and~~

~~4.1.13.3.2 provide such rights, facilities and services as are required to enable the ITTF and/or the relevant third party to fulfil their obligations under any arrangements for the exploitation of any of the Commercial Rights and shall not by any act or omission infringe any exclusive rights granted there under or otherwise cause any breach thereof to occur. For the avoidance of doubt only the ITTF may enforce this rule against an Association and no third party shall be entitled to do so.~~

4.2 WORLD JUNIOR YOUTH CHAMPIONSHIPS

4.2.1 Authority for Organisation

4.2.1.1 The title "World Junior Youth Championships", referred to in this Section as "Championships", shall be bestowed by the AGM Board of Directors on the championship events at a tournament organised by an Association entrusted with the task.

4.2.1.2 The closing date for applications to stage Championships shall be specified by the Executive Committee and notified to all Associations, giving at least 6 months' notice; applications shall be accepted only for the next 2 Championships.

- 4.2.1.3 All applications shall be considered by the Executive Committee and a short list shall be submitted to the Board., ~~together with details on venues for the occasion in question.~~
- 4.2.1.4 Where necessary, the Board or the Executive Committee may ask the Junior Commissioner Competition Department to visit the country of an Association applying for the right to organise the Championships to satisfy themselves as to the adequacy of the proposed playing and other arrangements; the cost of such visits shall be borne by that Association.
- 4.2.1.5 If, after an option has been granted, circumstances change in such a way as to be likely to prejudice the satisfactory conduct of the Championships, the option may be revoked by a 2/3 majority vote at the AGM preceding the Championships; between AGMs the Board of Directors shall have power to transfer the Championships or to take any other appropriate action.

4.2.2 Responsibilities of Organisers

- 4.2.2.1 An Association granted the right to organise the Championships, hereafter referred to as the "organisers" shall be responsible for conducting them in accordance with the Laws of Table Tennis, the Regulations for International Competitions and the Regulations for World Junior Youth Championships, as modified or supplemented by any directives authorised by the Board of Directors and the Event Manuals (Event Directives and Requirements) as developed by the ITTF.
- ~~4.2.2.2 Organisers shall provide accommodation and meals from lunch on the day before the Championships begin until breakfast on the day after the Championships end for~~
- ~~4.2.2.2.1 not more than 2 boys players nominated by an Association eligible for the boys team event;~~
- ~~4.2.2.2.2 not more than 2 girls players nominated by an Association eligible for the girls team event;~~
- ~~4.2.2.2.3 not more than 1 coach of an Association participating in 1 or 2 team events;~~
- ~~4.2.2.2.4 members of the ITTF Executive Committee and the Junior Commissioner;~~
- ~~4.2.2.2.5 up to 2 Doping Control Supervisors appointed by the Sports Science and Committee;~~
- ~~4.2.2.2.6 up to 2 ITTF Committee or Commission Chairs nominated by the Executive Committee;~~
- ~~4.2.2.2.7 International Umpires, Referees and Evaluators from other Associations invited in accordance with the ITTF directives for match officials at World Title Competitions;~~
- ~~4.2.2.2.8 up to 7 members of the ITTF staff.~~

- ~~4.2.2.3 Organisers shall provide free medical care and medicine for all participants, but each Association is recommended to insure its players and officials against illness and injury for the duration of the Championships.~~
- ~~4.2.2.4 Organisers shall meet the cost of transport between the place of accommodation and the playing hall.~~
- ~~4.2.2.5 Organisers shall request their national authorities to waive visa charges for all participants.~~
- ~~4.2.2.6 Organisers shall ensure free access to the playing hall and free circulation therein for all the players, officials and members listed in 4.2.2.2, for any additional players and ITTF officials and for any interpreter, doctor or medical adviser appointed by the ITTF.~~
- ~~4.2.2.7 Organisers shall provide the ITTF with offices at the venue of the Championships and place at its disposal translation, computer, internet, telephone, telefax and duplicating facilities.~~
- ~~4.2.2.8 Organisers shall publish a prospectus giving the main details of the organisation of the Championships, including~~
- ~~4.2.2.8.1 the dates and place of the Championships;~~
- ~~4.2.2.8.2 the events to be held;~~
- ~~4.2.2.8.3 the equipment to be used;~~
- ~~4.2.2.8.4 the procedure for entry, the entry fees and the undertakings required;~~
- ~~4.2.2.8.5 the date and place of the draw;~~
- ~~4.2.2.8.6 the dates of Jury meetings;~~
- ~~4.2.2.8.7 the extent of hospitality for players and officials;~~
- ~~4.2.2.8.8 any directives authorised by the Board of Directors for the Championships.~~
- ~~4.2.2.9 During the Championships Organisers shall make available promptly to members of the ITTF Executive Committee, Board of Directors members and team captains details of results, including points scores; as soon as possible after the completion of the Championships Organisers shall publish the complete results, including points scores, and circulate them to all Associations.~~

4.2.3 Eligibility

- 4.2.3.1 Only an Association which is not in arrears (1.7.3.3) shall be eligible to enter teams or individual players in the Championships.
- ~~4.2.3.2 The system of qualification for team and individual events shall be determined by the Board **Executive Committee** not later than 18 months before the start of the Championships.~~
- 4.2.3.3 All players shall be juniors **U19** and **U15** according to 3.7.4.2.

- 4.2.3.4 In addition to provisions of 3.8, players who have acquired a new nationality and wish to represent the a Association corresponding to the new nationality shall register with ITTF through this new Association. A player is considered as registered either from the date of ITTF player registration confirmation or from the date the player is granted his or her new nationality, whichever is earlier.
- 4.2.3.5 Such player shall not represent the new Association before 3 years after the date of registration, if the player is under the age of 15 when registered, but only 1 year after the date of registration if the player has never represented another a Association.
- 4.2.3.6 Players being 15 years of age or older at the date of registration cannot represent their new Association at World Junior Youth Championships except that a player having participated already in World Junior / Youth Championships shall retain his or her eligibility.

4.2.4 — Entry Fees

- ~~4.2.4.1 The entry fees shall be US\$50 for each entry in a team event, US\$30 for each pair in a doubles event and US\$15 for each entry in a singles event.~~
- ~~4.2.4.2 The entry fees shall be paid to the organisers at the time of entry and shall be shared equally between the organisers and the ITTF.~~
- ~~4.2.4.3 Fees for entries from an Association are due from that Association and shall always be payable, except that the Board of Directors may waive the fees where an Association is prevented from participating in the Championships by circumstances outside its control.~~

4.2.5 — Qualification and Entries

- ~~4.2.5.1 The intention of an Association qualified to enter teams or players shall be notified to the organisers and the ITTF in a preliminary notification form provided by the Secretariat; the closing date for the receipt of this form shall be not later than 4 calendar months before the start of the Championships.~~
- ~~4.2.5.2 Information shall be distributed, together with the prospectus, by the Competition Department and entries shall be submitted as required.~~
- ~~4.2.5.3 Two sets of these entry forms shall be returned to the organisers and one set to the Secretariat; the closing date for the receipt of these forms shall be not later than 2 calendar months before the start of the Championships.~~
- ~~4.2.5.4 An Association may nominate up to 4 qualified boys and up to 4 qualified girls players.~~
- ~~4.2.5.5 An Association shall rank its nominated players and pairs in order of playing strength, which shall be consistent with their current ranking in the World Junior Ranking List.~~

~~4.2.5.6 — Organisers may accept only formal nominations by an eligible Association, which are received, properly signed by a responsible representative of the nominating Association, on or before the closing date.~~

~~4.2.6 — Modification of Entries~~

~~4.2.6.1 — The nominating Association may change the composition of a team by notifying the organisers up to the time of the Jury meeting preceding the Championships, but in no circumstances after the start of the event.~~

~~4.2.6.2 — As soon as he or she arrives at the Championships venue, the representative of an Association requesting a change to the draw in consequence of any error or absence shall notify the referee or his or her deputy, or confirm any change already notified, on a form provided for the purpose.~~

~~4.2.6.3 — A request for modification of an entry cannot be considered unless it is made or confirmed by the representative of an Association immediately on arrival, other than a request based on the subsequent absence, illness or injury of one player of a doubles pair, which shall be made as soon as the contingency arises.~~

~~4.2.6.4 — All alterations that are authorised shall be notified immediately to team captains and, where appropriate, to Association representatives.~~

~~4.2.7 — Entry Obligations~~

~~4.2.7.1 — The entry form shall contain a statement, to be signed by a responsible representative of the nominating Association on behalf of all its nominated players and captains, that they understand and accept the conditions of the Championships and that they are prepared to compete against all other teams and individuals participating; no entry shall be valid unless accompanied by this declaration.~~

~~4.2.7.2 — In individual events all entrants are accepted as individual competitors; they shall be bound to do their utmost to win the events for which they are entered, irrespective of whether other entrants from the same Association have been accepted to take part, and they shall not withdraw except for reasons of illness or injury.~~

~~4.2.8 — Jury~~

~~4.2.8.1 — The Jury shall consist of the ITTF Junior Commissioner, a representative of the ITTF Competition Department, a representative of the ITTF World Junior Program, the Championships Director (or his or her equivalent), a representative of the organising committee and the referee; the referee shall have the right to speak but not to vote.~~

- ~~4.2.8.2 If the ITTF Junior Commissioner is unable to attend a meeting of the Jury he or she may nominate an appointee to attend in his or her place who shall have the right to speak and to vote.~~
- ~~4.2.8.3 The Chair of the Jury shall be appointed by the ITTF Junior Commissioner or in his or her absence by the representative of the ITTF World Junior Program.~~
- ~~4.2.8.4 Any Association directly affected by a matter under consideration at a Jury meeting shall be entitled to be represented at that meeting but shall not be entitled to vote.~~
- ~~4.2.8.5 The Jury shall have power to decide any question of appeal within the jurisdiction of a tournament management committee.~~
- ~~4.2.8.6 The Jury shall meet before the start of the Championships to be informed of all draw alterations requested up to that time; any subsequent questions of draw alteration shall be decided by the ITTF Junior Commissioner and the Jury shall meet again only when convened by the Junior Commissioner to consider appeals against its administrative decisions or decisions of the referee.~~

4.2.9 Events

- 4.2.9.1 The Championships shall include boys' team and girls' team events as well as boys' singles and doubles, girls' singles and doubles and mixed doubles events.
- ~~4.2.9.1.1 With the exception of mixed doubles events, both players of a doubles pair shall be from the same Association.~~
- 4.2.9.2 The system of play and the system of qualification in the team and individual events, shall be decided by ~~the Board of Directors, on the recommendation of~~ the Junior Commissioner, Technical Commissioner and the Competition Program Department, and shall be notified to all Associations not later than 6 calendar months before the start of the Championships.

~~4.2.10 Default~~

- ~~4.2.10.1 An Association whose team is entered in the draw but which fails to compete in the event without adequate justification may be subject to disciplinary action by the AGM.~~
- ~~4.2.10.2 A team may begin, continue and complete a team match only with the full complement of players specified for the event, except that the referee may, at his or her discretion, allow a team to play with one player absent or an individual match to be omitted from the sequence where he or she is satisfied that the absence is due to accident, illness, injury or other circumstances outside the control of the player or the Association concerned, including disqualification by the referee in accordance with his or her authority.~~
- ~~4.2.10.3 An Association whose team begins to play in the event but which fails to complete its schedule of matches shall be liable to forfeit its entitlement to~~

~~hospitality for its representatives at the Championships; an appeal against forfeit may be made to the Jury, whose decision shall be final.~~

~~4.2.11 — Doping Control~~

~~4.2.11.1 — Doping control shall be carried out in accordance with ITTF Anti-Doping rules (Chapter 5).~~

~~4.2.12 — Awards and Presentations~~

~~4.2.12.1 — In both team and individual events the winners shall receive gold medals, the losing finalists silver medals and the losing semi-finalists bronze medals.~~

~~4.2.12.2 — At presentation ceremonies for both team and individual events the national flags of the gold, silver and bronze medal winners shall be raised and the national anthem of the gold medal winner shall be played.~~

~~4.2.13 — Commercial Rights~~

~~4.2.13.1 — The ITTF exclusively owns and controls all commercial rights in and to the Championships. Such Commercial Rights to include, without limitation and in each case on a worldwide basis, all:~~

~~4.2.13.1.1 — audio, visual and audio-visual and data rights (in every medium, whether or not existing as at the date of these regulations);~~

~~4.2.13.1.2 — sponsorship, advertising, merchandising, marketing and other forms of rights of association;~~

~~4.2.13.1.3 — ticketing, hospitality and other concession rights; and~~

~~4.2.13.1.4 — other rights to commercialise the Championships (including without limitation any so-called "event rights" and any right to authorise the taking of bets on the Championships.~~

~~4.2.13.2 — The ITTF shall be entitled to exploit the Commercial Rights in such manner as it considers appropriate, including granting licences in respect of the same (or part thereof) to the relevant Association or to other third party(ies) from time to time.~~

~~4.2.13.3 — Each Association shall ensure that their members (officials, players, delegates and other affiliates) shall:~~

~~4.2.13.3.1 — comply with any and all rules, regulations and/or guidelines in relation to the exploitation of the Commercial Rights which may be issued from time to time by or on behalf of the ITTF; and~~

~~4.2.13.3.2 — provide such rights, facilities and services as are required to enable the ITTF and/or the relevant third party to fulfil their obligations under any arrangements for the exploitation of any of the Commercial Rights and shall not by any act or omission infringe any exclusive rights granted there under~~

~~or otherwise cause any breach thereof to occur. For the avoidance of doubt only the ITTF may enforce this rule against an Association and no third party shall be entitled to do so.~~

4.3 WORLD CUP

4.3.1 Composition

4.3.1.1 A World Cup for Men and a World Cup for Women shall be held awarded on an annual basis or every 2 years in even numbered years and Continental World Cups or an equivalent shall serve as the qualification for the World Cups. The qualification and playing system will be an integral part of the ITTF's Competition Program Department.

~~4.3.1.2 Participants will be provided with free meals and accommodation from dinner on the evening before the start of the competition to breakfast on the morning after it ends; continental representatives will also be provided with free return travel tickets to the venue.~~

4.3.2 Authority

4.3.2.1 The ITTF shall be the sole owner of the World Cup title and tournaments.

4.3.2.2 An Association may be granted permission to organise the tournament; submission of an application to do so shall be regarded as implying knowledge and acceptance of these and all other applicable regulations.

4.3.2.3 Organisers shall not, without prior consent of the ITTF, delegate any of their authority nor make any contract or agreement with any other body, such as a Regional Association, a municipal authority or a sponsor.

4.3.2.4 Any agreement made between the organisers and any other body shall not conflict with nor derogate from the principle of these regulations; in case of any dispute the authority of the ITTF, as exercised through its representatives, shall be paramount.

4.3.2.5 The ITTF may enter into contracts with promoters or sponsors.

~~4.3.3 Appointments~~

~~4.3.3.1 For each tournament the ITTF Competition Department shall appoint a Tournament Director and a Competition Manager.~~

~~4.3.3.2 The Tournament Director shall be responsible to the ITTF Competition Department for ensuring observance of the conditions laid down for the tournament, including approval of the arrangements made by the organisers for ceremonies and presentations, protocol and seating arrangements at ceremonies and social functions and the presentation of play.~~

~~4.3.3.3 The Competition Manager shall be responsible to the ITTF for ensuring the adequacy of equipment and playing conditions, supervising the draw and scheduling matches.~~

~~4.3.4 Doping Control~~

~~4.3.4.1 Doping control shall be carried out in accordance with ITTF Anti-Doping rules (Chapter 5).~~

4.3.5 Playing System

4.3.5.1 The playing system will be determined by the Executive Committee on recommendation by the Competition Department. The selected players and their ~~a~~ Associations will be informed of the playing system to be used in the prospectus at the same time as the issuance of the invitation to the participants.

~~4.3.6 Eligibility~~

~~4.3.6.1 In addition to provisions of 3.8, players who have acquired a new nationality and wish to represent the association corresponding to the new nationality shall register with ITTF through this new Association. A player is considered as registered either from the date of ITTF player registration confirmation or from the date the player is granted his or her new nationality, whichever is earlier.~~

~~4.3.6.2 Such player shall not represent the new Association before:~~

~~4.3.6.2.1 3 years after the date of registration, if the player is under the age of 15 when registered, but only 1 year after the date of registration if the player has never represented another association;~~

~~4.3.6.2.2 5 years after the date of registration, if the player is under the age of 18 but at least 15 years of age when registered;~~

~~4.3.6.2.3 7 years after the date of registration, if the player is under the age of 21 but at least 18 years of age when registered.~~

~~4.3.6.2.4 9 years after the date of registration, if the player is at least 21 years old when registered.~~

~~4.3.6.3 A player having participated already in the World Cup shall retain his or her eligibility.~~

~~4.3.7 Jury~~

~~4.3.7.1 The Jury shall consist of the ITTF Executive Vice-President responsible for the World Cup, the ITTF Director of Competition, a representative of the organising committee and the referee; the referee shall have the right to speak but not to vote.~~

- ~~4.3.7.2 — If either the ITTF Executive Vice-President responsible for the World Cup or the ITTF Director of Competition is unable to attend a meeting of the Jury he or she may nominate an appointee to attend in his or her place who shall have the right to speak and to vote.~~
- ~~4.3.7.3 — The Chair of the Jury shall be appointed by the ITTF Executive Vice-President responsible for the World Cup.~~
- ~~4.3.7.4 — Any Association directly affected by a matter under consideration at a Jury meeting shall be entitled to be represented at that meeting but shall not be entitled to vote.~~
- ~~4.3.7.5 — The Jury shall have power to decide any question of appeal within the jurisdiction of a tournament management committee.~~
- ~~4.3.7.6 — The Jury shall meet before the start of the tournament to be informed of all draw alterations requested up to that time and the Jury shall meet again only when it has to consider appeals against its administrative decisions or decisions of the referee.~~

~~4.3.8 Commercial Rights~~

- ~~4.3.8.1 — The ITTF exclusively owns and controls all commercial rights in and to the Championships. Such Commercial Rights to include, without limitation and in each case on a worldwide basis, all:~~
- ~~4.3.8.1.1 — audio, visual and audio-visual and data rights (in every medium, whether or not existing as at the date of these regulations);~~
- ~~4.3.8.1.2 — sponsorship, advertising, merchandising, marketing and other forms of rights of association;~~
- ~~4.3.8.1.3 — ticketing, hospitality and other concession rights; and~~
- ~~4.3.8.1.4 — other rights to commercialise the Championships (including without limitation any so-called "event rights" and any right to authorise the taking of bets on the Championships.~~
- ~~4.3.8.2 — The ITTF shall be entitled to exploit the Commercial Rights in such manner as it considers appropriate, including granting licences in respect of the same (or part thereof) to the relevant Association or to other third party(ies) from time to time.~~
- ~~4.3.8.3 — Each Association shall ensure that their members (officials, players, delegates and other affiliates) shall:~~
- ~~4.3.8.3.1 — comply with any and all rules, regulations and/or guidelines in relation to the exploitation of the Commercial Rights which may be issued from time to time by or on behalf of the ITTF; and~~
- ~~4.3.8.3.2 — provide such rights, facilities and services as are required to enable the ITTF and/or the relevant third party to fulfil their obligations under any~~

~~arrangements for the exploitation of any of the Commercial Rights and shall not by any act or omission infringe any exclusive rights granted there under or otherwise cause any breach thereof to occur. For the avoidance of doubt only the ITTF may enforce this rule against an Association and no third party shall be entitled to do so.~~

4.4 **WORLD TEAM WORLD CUP**

4.4.1 **Composition**

4.4.1.1 A ~~World~~ Team **World** Cup shall be ~~staged~~ **awarded** every 2 years in odd numbered years and the ~~Continental Team Champions shall be invited to take part.~~ The qualification and playing systems will be an integral part of the ITTF's Competition **Program Department**.

~~4.4.1.2 If the team of the host Association is qualified by its ranking at the preceding World Team Championships then the team placing 8th at these World Team Championships shall participate.~~

~~4.4.1.3 Participants will be provided with free meals and accommodation from dinner on the evening before the start of the competition to breakfast on the morning after it ends.~~

4.4.2 **Authority**

4.4.2.1 The ITTF shall be the sole owner of the ~~World~~ Team **World** Cup title and tournament.

4.4.2.2 An Association may be granted permission to organise the tournament; submission of an application to do so shall be regarded as implying knowledge and acceptance of these and all other applicable regulations.

4.4.2.3 Organisers shall not, without prior consent of the ITTF, delegate any of their authority nor make any contract or agreement with any other body, such as a Regional Association, a municipal authority or a sponsor.

4.4.2.4 Any agreement made between the organisers and any other body shall not conflict with nor derogate from the principle of these regulations; in case of any dispute the authority of the ITTF, as exercised through its representatives, shall be paramount.

4.4.2.5 The ITTF may enter into contracts with promoters or sponsors.

~~4.4.3~~ **Appointments**

~~4.4.3.1 For each tournament the ITTF Competition Department shall appoint a Tournament Director and a Competition Manager.~~

~~4.4.3.2 The Tournament Director shall be responsible to the ITTF Competition Department for ensuring observance of the conditions laid down for the tournament, including approval of the arrangements made by the organisers for ceremonies and presentations, protocol and seating arrangements at ceremonies and social functions and the presentation of play.~~

~~4.4.3.3 The Competition Manager shall be responsible to the ITTF for ensuring the adequacy of equipment and playing conditions, supervising the draw and scheduling matches.~~

~~4.4.4 Doping Control~~

~~4.4.4.1 Doping control shall be carried out in accordance with ITTF Anti-Doping rules (Chapter 5).~~

4.4.5 Playing System

4.4.5.1 The playing system shall be determined by the Executive Committee on recommendation by the Competition **Program Department**. The selected teams and their Associations shall be informed of the playing system to be used in the prospectus at the same time as the issuance of the invitation to the participants.

~~4.4.6 Eligibility~~

~~4.4.6.1 In addition to provisions of 3.8, players who have acquired a new nationality and wish to represent the association corresponding to the new nationality shall register with ITTF through this new Association. A player is considered as registered either from the date of ITTF player registration confirmation or from the date the player is granted his or her new nationality, whichever is earlier.~~

~~4.4.6.2 Such player shall not represent the new Association before~~

~~4.4.6.2.1 3 years after the date of registration, if the player is under the age of 15 when registered, but only 1 year after the date of registration if the player has never represented another association;~~

~~4.4.6.2.2 5 years after the date of registration, if the player is under the age of 18 but at least 15 years of age when registered;~~

~~4.4.6.2.3 7 years after the date of registration, if the player is under the age of 21 but at least 18 years of age when registered.~~

~~4.4.6.2.4 9 years after the date of registration, if the player is at least 21 years old when registered.~~

~~4.4.6.3 A player having participated already in the World Team Cup shall retain his or her eligibility.~~

~~4.4.7 Jury~~

- ~~4.4.7.1 The Jury shall consist of the ITTF Executive Vice-President responsible for the World Team Cup, the ITTF Director of Competition, a representative of the organising committee and the referee; the referee shall have the right to speak but not to vote.~~
- ~~4.4.7.2 If either the ITTF Executive Vice-President responsible for the World Team Cup or the ITTF Director of Competition is unable to attend a meeting of the Jury he may nominate an appointee to attend in his place who shall have the right to speak and to vote.~~
- ~~4.4.7.3 The Chair of the Jury shall be appointed by the ITTF Executive Vice-President responsible for the World Team Cup.~~
- ~~4.4.7.4 Any Association directly affected by a matter under consideration at a Jury meeting shall be entitled to be represented at that meeting but shall not be entitled to vote.~~
- ~~4.4.7.5 The Jury shall have power to decide any question of appeal within the jurisdiction of a tournament management committee and to authorise team changes.~~
- ~~4.4.7.6 The Jury shall meet before the start of the tournament to be informed of all draw alterations requested up to that time and the Jury shall meet again only when it has to consider appeals against its administrative decisions or decisions of the referee.~~

~~4.4.8 Commercial Rights~~

- ~~4.4.8.1 The ITTF exclusively owns and controls all commercial rights in and to the Championships. Such Commercial Rights to include, without limitation and in each case on a worldwide basis, all:~~
- ~~4.4.8.1.1 audio, visual and audio-visual and data rights (in every medium, whether or not existing as at the date of these regulations);~~
- ~~4.4.8.1.2 sponsorship, advertising, merchandising, marketing and other forms of rights of association;~~
- ~~4.4.8.1.3 ticketing, hospitality and other concession rights; and~~
- ~~4.4.8.1.4 other rights to commercialise the Championships (including without limitation any so-called "event rights" and any right to authorise the taking of bets on the Championships.~~
- ~~4.4.8.2 The ITTF shall be entitled to exploit the Commercial Rights in such manner as it considers appropriate, including granting licences in respect of the same (or part thereof) to the relevant Association or to other third party(ies) from time to time.~~
- ~~4.4.8.3 Each Association shall ensure that their members (officials, players, delegates and other affiliates) shall:~~

~~4.4.8.3.1 — comply with any and all rules, regulations and/or guidelines in relation to the exploitation of the Commercial Rights which may be issued from time to time by or on behalf of the ITTF; and~~

~~4.4.8.3.2 — provide such rights, facilities and services as are required to enable the ITTF and/or the relevant third party to fulfil their obligations under any arrangements for the exploitation of any of the Commercial Rights and shall not by any act or omission infringe any exclusive rights granted there under or otherwise cause any breach thereof to occur. For the avoidance of doubt only the ITTF may enforce this rule against an Association and no third party shall be entitled to do so.~~

4.5 OLYMPIC COMPETITIONS

4.5.1 Eligibility

4.5.1.1 To be eligible for participation in the Olympic Games a player, coach or official shall comply with the Olympic Charter as well as with the ITTF rules. In particular the above mentioned persons shall

4.5.1.1.1 be entered by their National Olympic Committee (NOC);

4.5.1.1.2 respect the spirit of fair play and non-violence, and behave accordingly on the field of play;

4.5.1.1.3 respect and comply in all aspects with the World Anti-Doping Code;

4.5.1.1.4 not allow their person, name, picture or sports performances to be used for advertising purposes during the Olympic Games, except as permitted by the IOC Executive Board.

4.5.1.2 The entry or participation of a player in the Olympic Games shall not be conditional on any financial consideration.

4.5.1.3 Any player shall be a national of the country of the NOC which is entering him or her.

4.5.1.3.1 A player who is a national of 2 or more countries at the same time may represent either one of them, as he or she may elect.

4.5.1.3.2 After having represented one country in the Olympic Games, in continental or regional games or in world or regional championships recognised by the ITTF, a player may not represent another country unless he or she meets the conditions set forth in 4.5.1.3.3.

4.5.1.3.3 In addition to provisions of 3.8, players who have acquired a new nationality and wish to represent the NOC of the new Association in the Olympic Games shall register with ITTF through this new Association. A player is considered as registered either from the date of ITTF player registration confirmation or from the date the player is granted his or her new nationality, whichever is earlier.

- 4.5.1.3.4 A player shall not represent the new NOC before:
- 4.5.1.3.4.1 3 years after the date of registration, if the player is under the age of 15 when registered, but only 1 year after the date of registration if the player has never represented another Association;
- 4.5.1.3.4.2 5 years after the date of registration, if the player is under the age of 18 but at least 15 years of age when registered;
- 4.5.1.3.4.3 7 years after the date of registration, if the player is under the age of 21 but at least 18 years of age when registered.
- 4.5.1.3.4.4 9 years after the date of registration, if the player is at least 21 years old when registered.
- 4.5.1.3.5 If an associated state, province or overseas department, a country or colony acquires independence, if a country becomes incorporated within another country by reason of a change of border, or if a new NOC is recognised by the IOC, a player may continue to represent the country to which he or she belongs or belonged. However, he or she may, if he or she prefers, choose to represent his or her country or be entered in the Olympic Games by his or her new NOC if one exists. This particular choice may be made only once.
- 4.5.1.4 A player having participated already in the Olympic Games shall retain his or her eligibility.
- 4.5.1.5 All disputes relating to the determination of the country which a player may represent in the Olympic Games and in particular issue specific requirements relating to nationality, citizenship, domicile or residence of the player, including the duration of any waiting period, shall be resolved by the IOC Executive Board.

4.5.2 Events

- 4.5.2.1 The Olympic competition shall include at least men's singles, women's singles, mixed doubles, men's team and women's team events.
- 4.5.2.2 The Team Match System in team events and the system of play in both team and individual events including any qualifying competitions shall be decided by the Board of Directors, on the recommendation of the Olympic and Paralympic Commission, and all Associations shall be notified in accordance with the schedule set by the IOC.
- 4.5.2.3. Players of the same Association shall be separated according to 3.6.3.1 and 3.6.3.3 only in preliminary rounds but not in further rounds.

~~4.5.3 Doping Control~~

- ~~4.5.3.1 Doping control shall be carried out in accordance with IOC rules and the World Anti-Doping Code.~~

4.6 PARALYMPIC COMPETITIONS

4.6.1 Eligibility

- 4.6.1.1 To be eligible for participation in the Paralympic Games a player, coach or official shall comply with the constitution of the International Paralympic Committee (IPC) as well as with the ITTF rules. In particular the above mentioned persons shall:
- 4.6.1.1.1 be entered by their National Paralympic Committee (NPC);
 - 4.6.1.1.2 respect the spirit of fair play and non-violence, and behave accordingly on the field of play;
 - 4.6.1.1.3 respect and comply in all aspects with the World Anti-Doping Code;
 - 4.6.1.1.4 not allow their person, name, picture or sports performances to be used for advertising purposes during the Paralympic Games, except as permitted by the IPC Governing Board.
- 4.6.1.2 The entry or participation of a player in the Paralympic Games shall not be conditional on any financial consideration.
- 4.6.1.3 Any player shall be a national of the country of the NPC which is entering him or her.
- 4.6.1.3.1 A player who is a national of 2 or more countries at the same time may represent either one of them, as he or she may elect.
 - 4.6.1.3.2 After having represented one country in the Paralympic Games, in continental or regional games or in world or regional championships recognised by the ITTF, a player may not represent another country unless he or she meets the conditions set forth in 4.6.1.3.3.
 - 4.6.1.3.3 In addition to provisions of 3.8, players who have acquired a new nationality and wish to represent the NPC of the new Association shall register with ITTF through this new Association. A player is considered as registered either from the date of ITTF player registration confirmation or from the date the player is granted his or her new nationality, whichever is earlier.
 - 4.6.1.3.4 A player shall not represent the new NPC before:
 - 4.6.1.3.4.1 3 years after the date of registration, if the player is under the age of 15 when registered, but only 1 year after the date of registration if the player has never represented another Association;
 - 4.6.1.3.4.2 5 years after the date of registration, if the player is under the age of 18 but at least 15 years of age when registered;
 - 4.6.1.3.4.3 7 years after the date of registration, if the player is under the age of 21 but at least 18 years of age when registered.

- 4.6.1.3.4.4 9 years after the date of registration, if the player is at least 21 years old when registered.
- 4.6.1.3.5 If an associated state, province or overseas department, a country or colony acquires independence, if a country becomes incorporated within another country by reason of a change of border, or if a new NPC is recognised by the IPC, a player may continue to represent the country to which he or she belongs or belonged. However, he or she may, if he or she prefers, choose to represent his or her country or be entered in the Paralympic Games by his or her new NPC if one exists. This particular choice may be made only once.
- 4.6.1.4 A player having participated already in the Paralympic Games shall retain his or her eligibility.
- 4.6.1.5 All disputes relating to the determination of the country which a player may represent in the Paralympic Games and in particular issue specific requirements relating to nationality, citizenship, domicile or residence of the player, including the duration of any waiting period, shall be resolved by the IPC Governing Board.

4.6.2 Events

- 4.6.2.1 The Paralympic competition shall include at least men's and women's class singles, men's and women's team events and any other event included by the IPC Governing Board on the recommendation of the Olympic and Paralympic Commission (OPC).
- 4.6.2.2 The Team Match System in team events and the system of play in both team and individual events including any qualifying competitions shall be decided by the Board of Directors, on the recommendation of the OPC, and all Associations shall be notified in accordance with the schedule set by the IPC.

~~4.6.3 Doping Control~~

- ~~4.6.3.1 Doping control shall be carried out in accordance with IPC rules and the World Anti-Doping Code.~~

4.7 WORLD PARA TABLE TENNIS CHAMPIONSHIPS

4.7.1 Authority for Organisation

- 4.7.1.1 The title "World Para Table Tennis Championships", referred to in this Section as "Para TT Championships", shall be bestowed by the Executive Committee on the championship events at a tournament organised by an Association entrusted with the task.

- 4.7.1.2 The closing date for applications to stage the Para TT Championships shall be specified by the Executive Committee and notified to all Associations, giving at least 6 months' notice.
- 4.7.1.3 All applications shall be considered by the Executive Committee together with the report of the ~~Selection Committee~~ **Competition Department**, if applicable; ~~on venues for the occasion in question.~~
- 4.7.1.4 Where necessary, the Executive Committee may ask one or more members of the appropriate Committee to visit the country of an Association applying for the right to organise the Para TT Championships to satisfy themselves as to the adequacy of the proposed playing and other arrangements; the cost of such visits shall be borne by that Association.
- 4.7.1.5 If, after an option has been granted, circumstances change in such a way as to be likely to prejudice the satisfactory conduct of the Para TT Championships, the option may be revoked by the Executive Committee prior to the Para TT Championships.

4.7.2 Responsibilities of Organisers

- 4.7.2.1 An Association granted the right to organise the Para TT Championships, hereafter referred to as the "organisers" shall be responsible for conducting them in accordance with the Laws of Table Tennis, the Regulations for International Competitions and the Regulations for World Title Competitions, as modified or supplemented by any directives authorised by the Board of Directors.
- ~~4.7.2.2 Organisers shall provide accommodation and meals from the evening before the Para TT Championships begin until the morning after the Para TT Championships end for:~~
- ~~4.7.2.2.1 members of the ITTF Executive Committee and the Para Table Tennis Committee;~~
- ~~4.7.2.2.2 International Umpires and Referees from other Associations invited in accordance with directives issued by the ITTF;~~
- ~~4.7.2.2.3 five international classifiers invited in accordance with directives issued by the ITTF;~~
- ~~4.7.2.2.4 up to 3 members of the ITTF staff.~~
- ~~4.7.2.3 If the business of the ITTF extends outside the period of the Para TT Championships the period of hospitality for those entitled to participate in such business shall be extended correspondingly.~~
- ~~4.7.2.4 Organisers shall provide free medical care and medicine for all participants, but each Association must insure its players and officials against illness and injury for the duration of the Para TT Championships.~~

- ~~4.7.2.5 — Organisers shall meet the cost of transport between the place of arrival in the country, the accommodation and the playing hall.~~
- ~~4.7.2.6 — Organisers shall request their national authorities to waive visa charges for all participants.~~
- ~~4.7.2.7 — Organisers shall ensure free access to the playing hall and free circulation therein for all the players, officials and members listed in 4.7.2.2, for any additional players and committee members and for any interpreter, doctor or medical adviser appointed by the ITTF.~~
- ~~4.7.2.8 — Organisers shall provide first-class interpreting in at least English.~~
- ~~4.7.2.9 — Organisers shall provide the ITTF with offices at the venue of the Championships and place at its disposal translation, computer, internet, telephone, telefax and copying facilities.~~
- ~~4.7.2.10 — Organisers shall publish a prospectus giving the main details of the organisation of the Para TT Championships, including:~~
- ~~4.7.2.10.1 — the dates and place of the Para TT Championships;~~
- ~~4.7.2.10.2 — the events to be held;~~
- ~~4.7.2.10.3 — the equipment to be used;~~
- ~~4.7.2.10.4 — the procedure for entry, the entry fees and the undertakings required;~~
- ~~4.7.2.10.5 — the date and place of the draw;~~
- ~~4.7.2.10.6 — the dates of Jury meetings;~~
- ~~4.7.2.10.7 — the extent of hospitality for technical and ITTF officials;~~
- ~~4.7.2.10.8 — accessibility for persons with a disability in the accommodation, transport and venues;~~
- ~~4.7.2.10.9 — maximum numbers of players and officials;~~
- ~~4.7.2.10.10 — any directives authorised by the Board of Directors for the Para TT Championships.~~
- ~~4.7.2.11 — During the Para TT Championships Organisers shall make available promptly to members of the ITTF Executive Committee, the Para TT Committee and team managers details of results, including points scores; as soon as possible after the completion of the Para TT Championships Organisers shall publish the complete results, including points scores, and circulate them to all Associations.~~

4.7.3 Eligibility

- 4.7.3.1 Only an Association which is not in arrears (1.7.3.3) shall be eligible to enter teams or individual players for the Para TT Championships.
- 4.7.3.2 In addition to provisions of 3.8, players who have acquired a new nationality and wish to represent the a Association corresponding to the new nationality

shall register with ITTF through this new Association. A player is considered as registered either from the date of ITTF player registration confirmation or from the date the player is granted his or her new nationality, whichever is earlier.

- 4.7.3.3 Such player shall not represent the new Association before:
 - 4.7.3.3.1 3 years after the date of registration, if the player is under the age of 15 when registered, but only 1 year after the date of registration if the player has never represented another Association;
 - 4.7.3.3.2 5 years after the date of registration, if the player is under the age of 18 but at least 15 years of age when registered;
 - 4.7.3.3.3 7 years after the date of registration, if the player is under the age of 21 but at least 18 years of age when registered.
 - 4.7.3.3.4 9 years after the date of registration, if the player is at least 21 years old when registered.
- 4.7.3.4 A player having participated already in the World Para Table Tennis Championships shall retain his or her eligibility.

~~4.7.4 — Entry and Capitation Fees~~

- ~~4.7.4.1 — The entry fees shall be set by the Organisers and approved by the Para TT Committee.~~
- ~~4.7.4.2 — The entry fees shall be paid to the Organisers at the time of entry and shall include capitation fees set by the Para TT Committee from time to time.~~
- ~~4.7.4.3 — Fees for entries from an Association are due from that Association and shall always be payable, except that the Board of Directors may waive the fees where an Association is prevented from participating in the Para TT Championships by circumstances outside its control.~~

~~4.7.5 — Submission of Entries~~

- ~~4.7.5.1 — The closing date/s for entries shall be decided by the Organisers and approved by the Para TT Committee but shall not be later than 2 calendar months before the start of the Para TT Championships.~~
- ~~4.7.5.2 — Entries by number and name shall be submitted on forms distributed, together with the prospectus, by the Organisers.~~
- ~~4.7.5.3 — An Association may enter up to 3 players per class and 1 team per class per country.~~
- ~~4.7.5.4 — An Association shall rank its players in order of playing strength, which shall be consistent with their current world ranking.~~
- ~~4.7.5.5 — The ITTF may accept only formal nominations by an eligible Association, which are received, properly signed by a responsible representative of the nominating Association, on or before the closing date.~~

~~4.7.6~~ — ~~Modification of Entries~~

~~4.7.6.1~~ — ~~Entries by an Association may be modified with the approval of the Technical Delegate.~~

~~4.7.6.2~~ — ~~Entries may be modified by the referee on the advice of the Chief Classifier.~~

~~4.7.7~~ — ~~Entry Obligations~~

~~4.7.7.1~~ — ~~The entry form shall contain statements committing team members to the ITTF Anti-Doping Rules, the ITTF Classification Code, to be signed by a responsible representative of the nominating Association and all players and officials, that they understand and accept the conditions of the Para TT Championships and that they are prepared to compete against all other teams and individuals participating; no entry shall be valid unless accompanied by this declaration.~~

~~4.7.7.2~~ — ~~In individual events all entrants are accepted as individual competitors; they shall be bound to do their utmost to win the events for which they are entered, irrespective of whether other entrants from the same Association have been accepted to take part, and they shall not withdraw except for reasons of illness or injury.~~

~~4.7.8~~ — ~~Jury~~

~~4.7.8.1~~ — ~~The Jury shall consist of 3 representatives appointed by the Para TT Committee.~~

~~4.7.8.2~~ — ~~Any Association directly affected by a matter under consideration at a Jury meeting shall be entitled to be represented at that meeting but shall not be entitled to vote.~~

~~4.7.8.3~~ — ~~The Jury shall have power to decide any question of appeal within the jurisdiction of a tournament management committee and to authorise team and classification changes.~~

~~4.7.8.4~~ — ~~The Jury shall meet before the start of the Championships to be informed of all draw alterations up to that time and the Jury shall meet again to consider appeals against administrative and classification decisions or decisions of the referee.~~

4.7.9 **Events**

4.7.9.1 The Para TT Championships shall include at least men's and women's class singles, men's and women's team events and any other event included by Para TT Committee.

4.7.9.2 The system of play in events and its implementation date shall be decided by the ~~Para TT Committee~~ **Competition Department**, on the recommendation of the Technical Commissioner.

~~4.7.10~~ — ~~Doping Control~~

~~4.7.10.1 Doping control shall be carried out in accordance with ITTF Anti-Doping rules (Chapter 5).~~

~~4.7.11~~ — ~~Awards and Presentations~~

~~4.7.11.1 In both team and individual events, the winners shall receive gold medals, the losing finalists silver medals and the winners of the bronze medal play-off bronze medals.~~

~~4.7.11.2 At presentation ceremonies for both team and individual events the national flags of the gold, silver and bronze medal winners shall be raised and the national anthem of the gold medal winner shall be played.~~

~~4.7.12~~ — ~~Commercial Rights~~

~~4.7.12.1 The ITTF exclusively owns and controls all commercial rights in and to the Championships. Such Commercial Rights to include, without limitation and in each case on a worldwide basis, all:~~

~~4.7.12.1.1 audio, visual and audio-visual and data rights (in every medium, whether or not existing as at the date of these regulations);~~

~~4.7.12.1.2 sponsorship, advertising, merchandising, marketing and other forms of rights of association;~~

~~4.7.12.1.3 ticketing, hospitality and other concession rights; and~~

~~4.7.12.1.4 other rights to commercialise the Championships (including without limitation any so-called "event rights" and any right to authorise the taking of bets on the Championships.~~

~~4.7.12.2 The ITTF shall be entitled to exploit the Commercial Rights in such manner as it considers appropriate, including granting licences in respect of the same (or part thereof) to the relevant Association or to other third party(ies) from time to time.~~

~~4.7.12.3 Each Association shall ensure that their members (officials, players, delegates and other affiliates) shall:~~

~~4.7.12.3.1 comply with any and all rules, regulations and/or guidelines in relation to the exploitation of the Commercial Rights which may be issued from time to time by or on behalf of the ITTF; and~~

~~4.7.12.3.2 provide such rights, facilities and services as are required to enable the ITTF and/or the relevant third party to fulfil their obligations under any arrangements for the exploitation of any of the Commercial Rights and shall not by any act or omission infringe any exclusive rights granted there under or otherwise cause any breach thereof to occur. For the avoidance of doubt only the ITTF may enforce this rule against an Association and no third party shall be entitled to do so.~~



Modification of T2 (Annex 2)

The net assembly

Content

Chapter 1 - The net assembly < link >

Introduction < link >

Terms of reference < link >

The function and general appearance < link >

Criteria for approval and recommendations for design < link >

- **Horizontal and upright parts of the net supporting posts** < link >
- **Net, net suspending cord and net attaching systems** < link >
- **The clamping system** < link >
 - **Removable clamping** < link >
 - **Permanent clamping** < link >
- **Net assembly sturdiness testing** < link >

Advertising, Identification and country of origin markings < link >

Show court net assemblies < link >

Technical devices attached to the net assembly < link >

Chapter 2 - Tension and height adjustment < link >

Adjustment systems < link >

Checks of tension and height at competitions < link >



Chapter 1: The Net Assembly

1.1 Introduction

The net assembly forms an important part of the equipment used in the game of table tennis and, in competitions, it is most exposed to TV cameras and an excellent medium for advertising. Its appearance is an essential factor for the presentation of the sport, and its handling must be safe and easy, also to guarantee necessary adjustments of height and tension in a non-fussy way.

The ITTF will only approve net assemblies to be used at International competitions if they reach the set benchmarks for high quality:

- ✚ Excellent appearance
- ✚ Safe operation
- ✚ Full observation of dimensions and properties as required by the present Technical Leaflet
- ✚ Permanent markings according to the rules
- ✚ Approval procedure followed as published on the ITTF Equipment website ([< link >](#)).

Although this leaflet refers to some specific methods of construction, the ITTF does not wish to restrict manufacturers to these methods, except where they are prescribed by the Laws and Regulations or the criteria for approval. Experiment and innovations are encouraged. However, only net assemblies whose net can be removed and replaced in a net post may get ITTF approval.

The ITTF will make its best effort to ensure that a trademark or brand name does not infringe on already existing net brands. Therefore, the supplier of a new net must verify and certify that they are the owner of the brand name. The ITTF is not responsible for any illegal use of registered trademarks, and verifying the correct and legal use of trademarks is not part of the ITTF approval procedure. Prior to ITTF approval, the design of special show court nets must be agreed by the ITTF Marketing department.

1.2 Terms of reference

Laws of Table Tennis

2.2: The Net Assembly

2.2.1: The net assembly shall consist of the net, its suspension and the supporting posts, including the systems attaching them to the table.

2.2.2: The net shall be suspended by a cord attached at each end to an upright post 15.25cm high, the outside limits of the post being 15.25cm outside the side line.

2.2.3: The top of the net, along its whole length, shall be 15.25cm above the playing surface.

2.2.4: The bottom of the net, along its whole length shall be as close as possible to the playing surface and the ends of the net shall be as close as possible to the supporting posts from top to bottom.

Regulations for International Competitions

3.2.1.2: state that "... net assembly...shall be selected from brands and types currently approved by the ITTF".

~~3.2.5.7: There may be 2 advertisements on nets on each side of the table which shall be clearly different from the colour of the ball in use, shall not be within 3cm of the tape along the top edge; advertisements placed on parts of the net within the vertical extensions of the side lines of the table shall not obscure visibility through the mesh.~~

In this leaflet, "net" refers to the fabric including tapes or bindings, "net post" to the upright and horizontal part of the post and the systems to attach it to the table and "net assembly" to the whole structure. The net assembly type (regulation 3.2.1.2) is called "model".

1.3 Function and general appearance of the net assembly

The net assembly is intended to provide a transparent, neat obstacle separating the court into 2 halves. Its structure shall force balls to cross over it to the opposite half without increasing the probability of lucky points from net balls. Its fabric shall be conceived in a way to permit non-permanent advertising markings to be applied.

As far as possible, a ball hitting the tape should fall back on the hitter’s side, or bounce over the tape, but not roll over to the receiver’s side. This implies that

- o the tension along the top of the tape should be high
- o below the top the tension should be significantly lower without being too loose
- o the bottom shall not be attached to the table top
- o the fabric shall not be stiff.

If the converse is true, the tape and fabric risk supporting a (topspin) ball, which hits slightly below the top of the net, to roll over.

Therefore, the fabric shall be:

- a) suspended by a cord, which must be tight and
- b) attached relatively firmly to the posts but hanging from the cord.

Apart from its function of making the top of the net clearly visible by its light colour, the tape is merely a means of suspending the mesh from the cord.

~~Some net assemblies are available which, although satisfactory in other respects, have no suspension cord, being suspended by tension applied from top to bottom of the post. This is absolutely unacceptable for competition, and nets so constructed shall not be approved by the ITTF or used in tournaments.~~

~~It will be readily seen that the art in designing a net assembly lies in devising a means of suspension so that the assembly can be readily set up, adjusted to the correct tension and height, and dismantled.~~

The appearance of the net assembly shall be neat and sturdy including

- firm, safe and nicely designed net posts and clamping systems
- even tapes or bindings demarcated by straight rims
- flat and even transition between tapes or bindings and fabric, not generating distorted, deformed or irregular mesh parts

No edges, corners or other parts of the net assembly shall risk to hurt the operator or player or to damage the table-top.

1.4 Criteria for approval and recommendations for design

The net posts may be cast, moulded or machined, although well-designed sheet-metal work can be adequate and may be approved. The upright post is preferably fixed integrally to the horizontal part, and it must stay vertical, when the net is mounted to the table. The dimensions given have to be observed.

Figure 1: Net supporting post

- 1 upright post
- 2 height adjustment
- 3 horizontal part of the net post
- 4 attaching system (clamp)

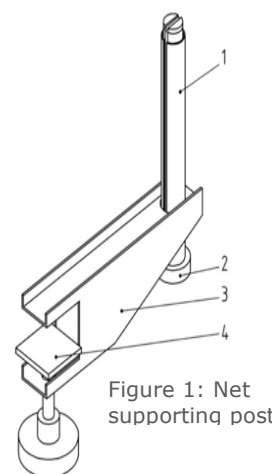

Figure 1: Net supporting post

1.4.1 Horizontal and upright parts of the net supporting posts

1. The structure of the upright post shall guarantee that the net can be suspended exactly at a height of 152.5mm above the playing surface in all circumstances: the adjustment device of a correctly clamped net assembly shall allow arranging any height between $152.5 + 2$ mm and $152.5 - 2$ mm.
2. The upright post shall be of the same height of 152.5 mm with a tolerance up to 155 mm. The outside limit of the upright post is $152.5\text{mm} \pm 2\text{mm}$ away from the side of the tabletop (figure 4).
3. The cross-section of the upright post shall be capable of being circumscribed by a 22mm square, and any device for adjusting the height of the net or the tension in the suspending cord shall not project more than 7mm outside the upright post (figure 4).

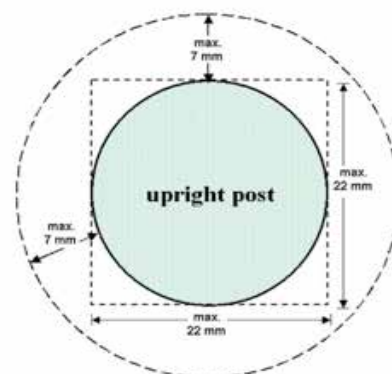

Figure 4: Cut through upright post

4. The horizontal part of the net supporting post shall not project more than 160mm outside the table-top side and not more than 100mm across the table surface towards its centre; for tables attached with a screw or spring clamp to the playing surface, this projection shall not be less than 80mm. The full height of the outside portion of the horizontal part shall not be more than 80mm, including any adjusting device. The height of the portion above the playing surface of the horizontal part shall not be more than 15mm. The width of the horizontal part shall not be more than 45mm and any device for adjusting the height of the net or the tension in the suspending cord shall not project more than 7mm on both sides (figure 5). **Figure xx**

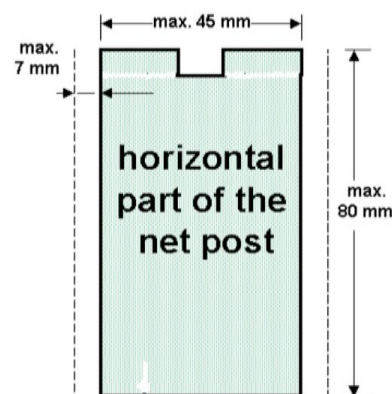

Figure 5: Cut through the horizontal part of the net post

5. Under the net, there may be a channel in the horizontal part of the net post, at least 4mm wide, and whose bottom shall be not more than 5mm above the playing surface.
6. The upright post shall be of a single, not glossy or luminescent colour, whose lightness L (CIE-Lab system) must be less than 60%.
7. A traction force applied transversally on the top of the upright post shall not detach or bend parts, or create any other damage; testing conditions are described later.

Upright net post (UP)				Horizontal part (HP) of net supporting post				
Height of UP	Cross-section square of UP	Outside of UP: distance to table side	Projection from UP of adjusting device	Outside of HP: distance to table side	Width of HP	Height of HP outside table side	Channel for net: . around mesh . under mesh . width	Projection over or under tabletop
h_1	w_2 / l_2	w_1	w_3 / l_3	w_1	l_1	h_2	$h_3 / h_4 / l_4$	w_4
< 155	≤ 22	152.5 ± 2	≤ 7	≤ 160	≤ 45	≤ 80	$\leq 15 / \leq 5 / \geq 4$	80 - 100
						includes adjusting parts		

Table 1 - Dimensions of the net supporting posts (all in mm) (Note: The abbreviations for the dimensions → figures, numbers of figures shall start at 1)



1.4.2 Net, net suspending cord and net attaching systems

A commercialized net must observe the following requirements:

- Full sight through the net is essential
- Any colour, but not glossy or fluorescent, is permitted
- At its top the tape, whose channel lodges the suspending cord, shall be white or pale yellow, and it shall be 12 to 15mm high
- At its ends, unless the mesh is firmly attached in some way inside the posts, and the binding is made of any material and of a dark colour, whose lightness L stays under 50 %, will be necessary; these end bindings, attaching the net to the post, shall be of the same colour as the mesh threads and not wider than 30 mm
- The height of the net, set up on the table, shall be at least 145mm and less than 150mm, i.e. there shall be no gap between net and table of more than 10 mm, and no part of the net shall touch the horizontal part of the net post or the table surface.
- The mesh and the top tape shall ~~not~~ be supple stiff (i.e. not stiffened by a resin coating, metallic or composite threads) to permit the tape to lie flat along the cord.
- The mesh shall not be so loose to allow balls passing under the net
- ~~This requirement also implies that the mesh should be made of spun fibre rather than single filament. Knots should be firm and regular.~~
- ~~In order to minimize the chance of a spinning ball climbing up the fabric,~~
- The dimensions of the net mesh and threads are as follows:
 - the thickness of the mesh threads must remain less than 2.0 mm
 - a side of a quadratic or rectangular mesh shall not be less than 7mm or more than 12mm.
 - a circular or hexagonal mesh may be considered providing it falls within a 12mm square section.
- A tape at the bottom of the net is not permitted, but the lower 10 mm may be designed in a decorative way, for instance with smaller and different meshes.

The net suspension or attachment shall observe the following requirements:

- The cord shall be non-elastic, flexible and strong enough to endure a strong traction; no part of it shall be sewed to the net
- The net must be attached to the upright posts from top to bottom. The use of auxiliary posts, outside the upright post, is not permitted.

Important remark about sewing along the bindings of the net.

- a) *Along the top of the net, the sewing confines the cord and holds the mesh*
- b) *Along the sides of the net, the sewing permits a strong fixation of the fabric and of the net to the post, ensures the required net height and provides regularity to the mesh*

Even if highest care is applied for having sewing straight and regular, a single line may not be sufficient to combine all requests for a firm and nice appearance. It is strongly recommended to have at least 2 lines of sewing. On the upper tape, one sewing line may create a channel, as narrow as possible to avoid parts of the tape standing up from the cord, but large enough to pull a cord through the channel.

During play	Net						Show net
	Height of fabric	Height of top tape	Height of bottom finish	Thread thickness	Mesh square section	Width of side binding	
h	h_{10}	h_{11}	h_{12}		h_{13}/w_{13}	w_{14}	w_{14}
152.5	145 - 149	12 - 15	≤ 10	< 2.0	7 - 12	≤ 30	≤ 80
adjustable	tape included		no tape permitted		thread included		

Table 2 - Dimensions of the net (all in mm)

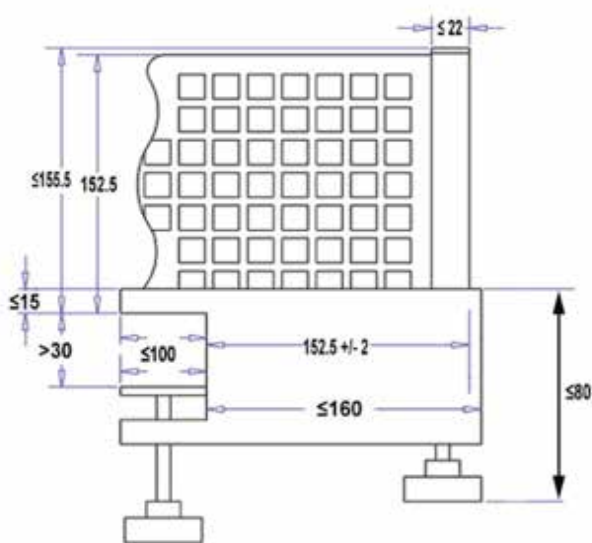

Figure 2: Front view

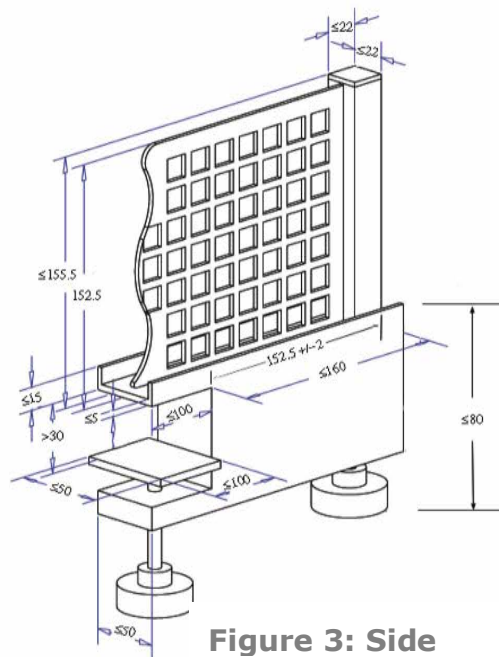

Figure 3: Side

The sewing along the tape at the top of the mesh serves two purposes:
 (a) It confines the cord, and (b) it holds the mesh.

We draw the attention of manufacturers to the fact that combining these functions into one line of sewing presents a difficulty. It is not easy to make that line of sewing absolutely straight and parallel to the playing surface. If it is not everywhere absolutely parallel to the mesh, then when the mesh is tensioned between the posts, however loosely, it will tend to align itself parallel to the table top, and the top of the tape cannot: parts of it will stand up from the cord, and will be further from the playing surface than the maximum height permitted. Possible solutions to this problem, besides more care in sewing, include different tape materials that will hang more limply, and an extra line of sewing much closer to the cord to create a free, narrower channel and not in the mesh at all.

1.4.3 Tension and height adjustment systems

Go to chapter 2 please. < link >

1.4.4 The clamping system

The net supporting posts must be firmly clamped to the table top to prevent the cord tension to pull the posts toward each other; testing will be described in the next section. The design of the clamp parts should permit a safe handling and not create damage to the table.

1.4.4.1 Removable clamping

Net supporting posts are removable if they need to be removed when the table is closed to the storage position.

The clamp shall observe the following requirements and recommendations:

Unless designed for a specific table, the clamp shall fit as many table tops as possible. Therefore

- Its opening should be at least 32 mm
- It should project no more than 100mm under the table-top
- It should be no more than 60mm wide under the table top

The supporting posts may be attached to the table top by a **C-screw clamp**.

- The clamp screw shall be easy to operate with the fingers and thumb, but the diameter of its head, gripped by the operator, shall not be greater than 30mm.



- The lower jaw of the clamp shall not rotate with the screw and not carry projections to avoid wearing away the underside of the table top. It should be cushioned with a strong, protecting material, without causing the post to wobble under tension. Its distal inset under the table shall be at least 60mm; its width or diameter shall be 40 to 60mm.
- The underside of the upper jaw should be similarly designed, for the same reasons.

The supporting posts may be attached to the table top by a **spring (clip) clamp**.

- The clamping force of the spring depend on the width and length of the jaws; its minimum may be 290 N.
- A safety clearance of at least 12 mm shall exist for the fingers when the clamp is removed from the table
- The opening range of the handle should be as small as possible allowing smaller hands to grip it and squeeze it to the net post, the recommended maximum being 80 mm.
- The manufacturers shall also keep in mind some safety precautions when designing the spring clamp:
 - The length of the movable clamping arm jaw may be chosen to guarantee the strongest attachment.
 - The higher the clamping force is, the longer the handle of the clamp shall be in order to reduce the force required for its opening.

1.4.4.2 Permanent clamping

Net supporting posts are permanent, if they do not need to or cannot be removed when the table is closed to the storage position.

A permanently attached net supporting post can be affixed either to the frame of the tabletop or to the undercarriage or to both. It should accept most of the approved nets and should be designed such that the net can be easily changed should that be necessary.

A safety clearance of at least 12 mm shall exist for the fingers between post and table side, when the table top is moved to or from the storage position.

Any parts of the attaching devices that are wider than 45mm shall observe the following conditions:

- at least 12mm below table-top level.
- length along the table-top side not more than 100mm from the net end.
- gap between device and table-top side at least 15mm, to avoid shearing.
- not more than 30mm outside of the table-top side.

Any other parts of the attaching devices of the net post, less wide than 45mm, shall observe both the restrictive dimensions given for the undercarriage of the tables and for the horizontal part of the net post. The sides of the horizontal part of the net supporting post must be designed in a way to allow a clear visual distinction between post and attaching or undercarriage parts.

Devices attaching the net assembly to the table (AP)							
Attachment with screw or spring clamp				Attachment: permanent net assemblies			
All clamps		Screw clamp	Clip	AP parts along the table top side			Other parts
Vertical opening of AP (rec.)	Jar above table depth x width	Jar under table: depth [w_6] x width [l_6] or diameter [l_5]	Jar under table: depth x width	Distance to table top side (gap)	Length along half table top side	Top below tabletop elevation	Belong to undercarriage or horizontal part of net supporting post
h_5	$w_5 \times l_1$	$(w_6) \times [l_6 \text{ or } l_5]$	$w_6 \times l_6$	w_7	l_7	h_7	
≥ 32	80-100 x (≤ 45)	(60-80) x [40-60]	$\geq 40 \times \geq 30$	12 - 18	≤ 100	≥ 12	

Table 3 - Dimensions of the net attaching devices AP (all in mm); rec. means "recommended".

Although it is desirable that a net assembly can be attached to any type of approved table, it will be seen from the above that some cannot. The manufacturer of such an assembly must be prepared to reach a restricted market.



1.5 Net assembly sturdiness testing (new section)

Suspending cord

Tensile strength: A 200 mm long cord segment shall resist a traction force of 300 N, repeated 20 times in-between maximum 10 minutes, without being torn or otherwise damaged (visual inspection).

Elasticity: A 100 N traction force is applied once during 1 minute on a 200 mm long cord segment, which

- shall not be stretched out by more than 35 mm or
- shall not remain extended by more than 10 mm, 15 minutes after its relaxation

Net posts with a screw clamp and permanent nets

The removable net post is clamped firmly to a table top (or another immovable 25 mm thick board). A 200 N transversal traction force is applied on the top of the upright net post, 5 times, each with vigour and during 1 minute. The top of the upright post shall not incline in direction of the force by more than 2 mm compared to its original position; and no part shall be bent or otherwise damaged (visual inspection).

Net posts with a spring clamp

Test a. An additional external clamp ensures that the front part of the upper jaw of the net clamp is immovably attached to an immovable support; the same test and requirements shall be fulfilled as for the screw clamp nets.

Test b. A 100 N transversal traction force is applied 5 times, each during 1 minute on the net only attached by its spring clamp to an immovable 25 mm thick board: the upright post shall not lift by more than 3 mm compared to its original height.

1.6 Show court net assemblies (new section)

For getting ITTF approval, show court net assemblies must follow all specifications of quality, safety and dimensions required for normal net assemblies.

However,

- The end bindings of show nets intended to wear non-permanent advertising markings above the horizontal part of the net post, may be wider than 30 mm, but no more than 80 mm. The surface of these wider parts must be perfectly even, matt and not textured.
- The parts of the net posts can be made of different material, but there shall not be more than two colours for the horizontal part and one colour for the upright post.

The permanent markings, the colour and the design of show court net assemblies must be agreed by the ITTF Marketing department or the tournament management before the approval procedure can be achieved and nets applied.

1.7 Advertising, Identification or Country of origin Markings

Net assembly: permanent advertising and identification markings

The following permanent markings are compulsory or optional:

1. The horizontal part of the net post of an ITTF approved net assembly must show
 - the supplier's brand name or logo and the model name
 - the ITTF logo either in black or white, depending on the background colour.
2. The horizontal tape of the net top
 - must wear the printed ITTF logo and approval code number of the net, once per net, both in black colour and together in a print area of less than 7 mm high and 20 mm wide, near to a net post.

- may wear the printed brand name or logo once per side; the print area shall be less than 7 mm high and 30 mm wide.

The pre-named print areas shall be located not more than 200 mm away from the centre of the upright net post.

No other permanent markings are permitted on the net assembly; markings on the upright posts or end bindings are prohibited.

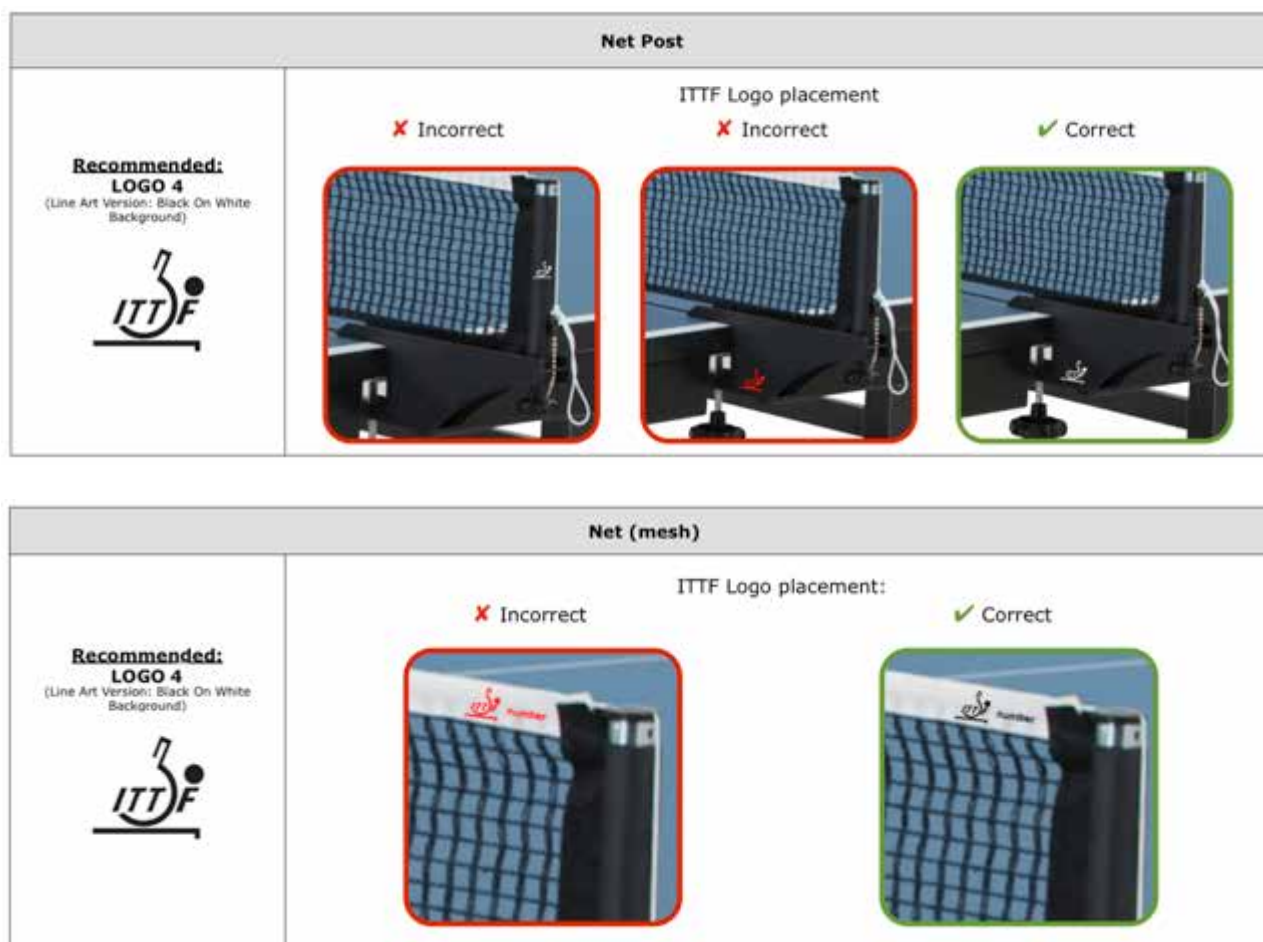

For more information, please refer to the ITTF Branding Guidelines: [<link>](#).

For the versions of the ITTF logo, please go to: [< link >](#)

Non-permanent advertising markings

Non-permanent advertisements on the net assembly are not part of the ITTF approval procedure. They shall follow the rules laid down for International Competitions the articles 3.2.5.3 and 3.2.5.7; they must be agreed beforehand by the tournament management.

Package: country of origin markings

The country of origin must be marked on the package, not on the net assembly.

- If **all** is made and assembled in the same country, simply print: «**Made in <Country>**»
- If the posts and the net (fabric) are made in **different countries**, print (both together not one of the two): "**net post made/assembled in <Country 1>, net (fabric) made in <Country 2>**".



1.8 Technical devices attached to the net assembly

In competitions, it may be desirable to attach objects such as microphones and video cameras to the net or post; according to the rule 3.2.3.9, they shall be considered as part of the net assembly. This shall not be done without prior advice from the net supplier of the Equipment Committee and agreement of the tournament management of the Referee and the Competition manager.

~~These devices must be small and, in absence of legislation on this matter, a maximum dimension of 30mm for anything attached to the post is suggested. Something attached to the net (mesh) must be much smaller than this, and should not affect its tension, shape or height. Nothing attached to either the post or the mesh shall project above the net height. These devices must be dark, matt and as inconspicuous as possible, and not emit light. They should be wireless; if not, their attached wires should also be dark and matt.~~

These devices and their attachment systems to the net assembly are not part of the approval procedure of the nets.

Chapter 2: Tension and height adjustment

2.1. Tension and height adjustment systems

Since the mesh is loose, its tension will not be adjusted. The cord, however, must be stretched and tightened manually after the assembly is set up; therefore, its ends should be fastened to a ball chain, ladder link chain or other adequate system, which can be hooked into a projection, notch, slot, or similar. The cord may also be attached to a mechanical device at one end, which either pulls it down or winds it round an axle. The tension adjustments may be by increments, which must be lower than 8 mm.

The top of the net should be 152.5mm above the playing surface. The top of the post, which has some means such as an indentation to prevent the cord from slipping off, can be raised or lowered to 152.5mm. ~~in order to compensate possible height deficiencies.~~ This adjustment is normally made by means of a screw under the upright post, but other methods are possible; they must not protrude from the maximum height (80mm) of the horizontal part of the net post. Preventions should be taken that the adjusting screw shall not detach from the movable part of the post.

Whatever system is selected, no part of it shall extend more than 7mm beyond the sides of the horizontal part of the net post. Other more sophisticated systems may be acceptable, if they are reliable and easy to handle.

In approving net assemblies, attention is given to the ease, safety and accuracy of making the tension or height adjustment.

2.2. Checks of tension and height at the table

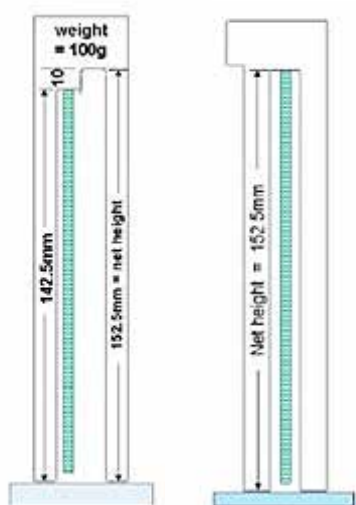

The tension of the net cord may be checked in the middle of the table either by fingers, or much better by a 100g **heavy tension gauge**. The ~~142mm to 143mm~~ 142.5mm high part of the gauge should hang on the net; the tension is good, if the bottom of the gauge comes next to the tabletop surface, but without or just touching it. Otherwise the devices to adjust the net tension must be operated.

The height of the net shall be checked about 30cm from the upright posts, but not in the middle of the table: ~~it shall reach the correct~~ the legal height must be adjusted accurately. The height should preferably be adjusted with the normal **light net gauge** that does not depress the net: the bottom of the freely and vertically hanging gauge should just touch the tabletop. Otherwise, the devices to adjust the net height have to be operated until the 152.5mm are reached.

Recommendations:

- The net tension and height shall always be checked and adjusted before the start of a tournament or some time before a match, so that at the start of the first or next match, only slight adjustments are required.
- First adjust tension, then height. Normally, the adjustment of the net tension is made by increments, not continuously, so that it remains approximative. Adjusting a low tension may increase the height of the net. The net height should be precisely 152.5 mm, therefore it may be adjusted after tension is regular.
- Tension and height gauges shall not be used together.
- After a significant decrease of the height, the tension may be too loose; in that case the tension may be checked and adjusted again.
- It happens that net meshes are stiffer than allowed: in that case the tension gauge does not work correctly; the cord tension has to be checked and adjusted without a gauge i.e. with fingers.
- ~~The heavy gauge can also be used for~~ may not be used for adjusting the height, because ~~but then it must be kept in mind that it always will push down the net, which will rise after taking off the gauge. Adjusting the height of a net with the heavy device requires a special care.~~

End of T2

Submitting body	ITTF EQUIPMENT COMMITTEE
------------------------	---------------------------------

Proposition (text see annex): **Modification of T3 "Balls"**

Abstract: The Equipment Committee proposes to

- Narrow the range of tolerances for several properties as indicated in the table included, taking into account existing improvements in manufacturing;
- Uniformize and simplify the use of trademark, brand and ball name and of packing, packaging and ball box; apply other cosmetic text improvements;
- Transfer more details to the already existing and published instructions related to the approval procedure, and only keep the principles in T3;
- Delete references to celluloid balls, while conserving the requirement of "celluloid-free" balls;
- Clarify that the sale and use of balls with a 2nd stamp on the balls is timely linked to the related event; (the EqC would like to discuss pros and cons at BoD ?)
- Prohibit mixing balls from different productions and sites, or selling balls with considerably different properties or appearance under the same name;
- Start testing balls with seams at positions more randomly chosen than just on seam and poles;

N.B. Please note that the technical requirements or testing methods are not changed at this moment. The EqC started a (statistical) analysis in order to evaluate, if the presently used specifications and testing methods are adequate for having balls, which bounce and behave in a regular, consistent way, as required by the players, or if new tests need to be created.

The changes in the sections "test procedures" and "specifications" are summed up in the table below. If there are questions about other details, the EqC is eager to provide adequate information, individually and at BoD.

They base on the statistical analysis of more than 1700 data recorded during the last years.

Modification of T3 Rationale

(Annex 3)

Specification		actually	In future	T3
Size conformity	Delete celluloid			B.3
Minimum		no change		
Maximum		40.60 mm	40.55 mm	
Sample mean		40.00 – 40.50 mm	40.00–40.40 mm	
Size regularity				B.4
Standard deviation		≤ 0.06 mm	≤ 0.04 mm	
Sphericity conformity	Delete celluloid			B.5
Sample mean lack of sphericity		≤ 0.20 mm	≤ 0.18 mm	
Sphericity regularity				B.6
Standard deviation		≤ 0.06 mm	≤ 0.04 mm	
Hardness conformity				B.10
With-in ball hardness: variation	Balls with seam	≤ 0.17 mm	≤ 0.15 mm	
Sample mean hardness: variation		≤ 0.08 mm	≤ 0.08 mm	
Other		no change		
	Balls without seam	no change		
Hardness regularity				B.11
Standard deviation		≤ 0.06 mm	≤ 0.04 mm	

Introduction

This leaflet describes, for the benefit of manufacturers and as a support to players the tests, which are applied to table tennis balls by the ITTF, and gives details of the criteria used in granting or withholding approval (chapters A - D). All ball brands approved have to meet all appearance standards and all qualitative and quantitative criteria described in the following sections. The procedure for ITTF approval is described in Technical Leaflet T7, and extended information about testing procedures are established by the Equipment Committee and are available to associations and manufacturers as an appendix to the present Technical Leaflet or from the ITTF.com web site.

A supplier may have ITTF-approved balls differing in:

- colour, i.e. white and orange
- material, i.e. ~~celluloid and non-celluloid~~ chemical composition, which must be celluloid-free
- seam type, i.e. with and without
- brand and ball name, which must be different when material or seam type differs

Terms of reference

The Laws of Table Tennis relating to the ball are as follows:

2.03 The Ball

2.03.01 The ball shall be spherical with a diameter of 40mm

2.03.02 The ball shall weigh 2.7g

2.03.03 The ball shall be made of celluloid or similar plastics material and shall be white or orange, and matt

Regulations for International Competitions require equipment authorized or approved by the ITTF.

~~Approval of Ball Brands~~

~~A supplier may have approved ball brands differing in:~~

- ~~• colour, i.e. white and orange~~
- ~~• material, i.e. celluloid and non-celluloid~~
- ~~• brand name and trademark~~

Material

~~Notwithstanding the instability and flammability of celluloid, it has always been the standard material for a table tennis ball. The Laws do not prescribe the material, leaving manufacturers free to experiment, in order to optimize it. We need better materials, and manufacturers are still encouraged to search for these and optimize them. Note however that, to ensure the quality of ITTF approved balls, the options for manufacturing are limited to a certain extent. In any case, the chemical composition must be non-flammable, especially celluloid-free.~~

~~The ITTF Equipment Committee will approve balls with a playing performance similar or identical to that of celluloid balls. Therefore, The performance and the specifications for celluloid-free balls are as identical as possible to the former ones for celluloid, with slight adjustments that proved reasonable to support the task of inventing a new material. Our goal is that balls of any material shall have the same good level of quality and stable properties, which must not change ~~at typical use before, during and after play,~~ except a regular ageing, which should be kept at a minimum. ~~E.g.:~~ Permanent indentations or stress whitening as well as a flimsy or battered appearance must be clearly avoided, as they affect the playing properties of the balls.~~

A. Qualitative Criteria and Appearance

A.1 General Appearance

The ball shall be white or orange, and matt (see B. 12). Balls of the same brand shall be identical in appearance, except that the same name may be used for white and orange balls. ~~Balls differing in colour may have the same trademark, but shall be otherwise identical in appearance.~~

A.2 Seam

A ball must appear to be uniform. In particular there must appear maximum ~~to be only~~ one seam. After the two halves of the ball have been jointed in manufacturing, the ball may be subsequently ~~moulded~~ treated for finishing. Note however that the ball must be smooth on the seam. Also, ~~if~~ if the equator of the ball - i.e. the joint - is not coplanar with the line of separation of the two halves of the mould, another line will be formed, looking like a second seam. This is not acceptable.

~~When there is no seam, artificial seams will be applied by the laboratory for testing purposes, refer "Appendix - Marking balls without seam" at the end of this document.~~

A.3 Stamp

The stamp on a ball may cover an area no greater than 280mm². It may be printed in one or two colours, but the same colour or combination must be used for all balls of the same ball brand, name and colour. The wording used in the stamp has to be in compliance with ITTF regulations (see chapter "C. Marking").

For designated events, the ITTF may allow a second stamp to be applied on balls which are already ITTF approved and will be used only in that event. In this case, the second stamp shall be antipodal to the first one. ~~on the opposite site of the sphere and the lettering of both stamps shall have the same orientation.~~ This means, if the center of the first stamp is interpreted as a point on the equator, the center of the second stamp shall be 180 degrees of longitude away and both letterings shall have their top side towards the north pole. The permission to print a second stamp and the design of the second stamp shall be individually authorized by the ITTF.

A.4 Packaging

The balls must be packaged appropriately, e.g. in paper or plastic boxes or in a blister pack. The wording used on ~~this package~~ each packing unit shall contain "40+" indicating non-celluloid balls. ~~either "40" or "40mm" for celluloid balls, or "40+" for non-celluloid balls.~~

Any ball pack unit ~~packing of the balls~~, even those for big quantities, must contain a date code and must be in compliance with the ITTF regulations (see chapter "C. Marking"). If a big package ~~ing~~ contains several small packings, this requirement applies to both.

A.5 Manufacturing

Only the following options are allowed for manufacturing an ITTF approved ball:

- a) the ball is completely produced by company **A** (i.e. only *one* manufacturer)
- b) the halves are made by injection moulding at company **A**, glueing and final steps at company **B**
- c) balls are produced through version a) or b) and sent to a final agent to make the final quality control under the obligation that all good balls will be stamped as ITTF approved quality (for example "3 star") and for a predefined brand, and that all failed balls will be treated differently (for example stamped as "1 star" or "2 star").

The following options are NOT allowed:

- d) to involve more than 2 manufacturers, for example halves produced in company A, glued in company B, final steps in company C, quality control in company D
- e) to send balls to an agent who decides on his own which quality will be stamped in which way and/or to which brand it is delivered
- f) to mix balls from different producers into the same ITTF APPROVED 3-Star product from one brand
- g) to mix balls of different colour tones in the same packaging and with same date code.

New materials, new manufacturing processes or a change of the producer, what could result in different properties, need to be announced to ITTF and require new testing.

B. Quantitative Criteria

Samples

Tests are conducted on groups of 24 balls; the number normally purchased is one package more than is needed to provide this number (i.e. usually 30 balls). Statistical "outliers", i.e. values which are so unlikely that an error cannot be excluded, are ignored when calculating means and standard deviations, but all values within a normal distribution but outside the permitted limits are included. All calculations of a standard deviation are assuming a sample and not a population, i.e. they use a denominator of "n-1".

Note: „Conformity“ means compliance with a specification set down in the Laws of Table Tennis or Regulations for International Competitions, and „regularity“ means degree of uniformity within a sample.

~~Anyone wishing to know how we analyze test results statistically is invited to contact the ITTF Equipment Manager.~~

Test Procedures

The ITTF equilibrates balls at 23° ($\pm 1^\circ$) Celsius, 50% ($\pm 5\%$) R.H. for at least three days (standard conditions according to Class 1 EN ISO 291). For seamless balls the colour test should be done first and then the ball should be equipped with artificial seams according to the Appendix.

Weight

The weight is ~~is~~ measured on an electronic analytical balance reading to 0.001g, and the results are rounded to the nearest 0.01g.

Diameter

~~We use a~~ A calibrated electronic device with a precision of at least 0.001mm ~~which~~ measures the diameter, and the results are rounded to the nearest ~~with a precision of~~ 0.01mm. The ball is fixed by a vertical pin (diameter 10mm). The force of the pin is kept as small as possible, but strong enough to guarantee that the ball remains ~~is absolutely~~ fixed. A force up to 5 (five) N has proved not to influence the diameter of the ball. For fixation the ball is supported by an annular ring whose upper inside surface slopes at an angle of 45 degrees. The outer diameter of the ring is 40mm and the inner diameter at the bottom of this slope is 20mm. In this position the ball is placed between two lateral, horizontal flat measuring pins (diameter 6mm), which automatically adapt to the ball diameter by soft springs. The force of the soft springs is between 0.5 and 1.5 N.

For balls with seam:

The diameter of the ball is monitored while turning the ball with a mechanical device about the polar axis (1), an axis crossing the equator twice perpendicularly and comprising the center (2), and about further two arbitrary axes comprising the center of the ball (3 & 4). By (1) the seam line, by (2) a line including both poles and by (3) and (4) arbitrary lines on the balls surface are monitored.

For balls without seam:

The diameter of the ball is monitored while turning the ball with a mechanical device about the red line (1), the blue line (2), the green line (3) and about one further arbitrary axis (4). By (1) the seam line, by (2) and (3) two lines including both poles and by (4) one arbitrary line on the balls surface are monitored.

For all balls:

By rotating the ball about the described axes, the minimum and maximum diameters are determined. The difference between the two values gives the lack of sphericity.

Alternatively, the following procedure can be applied: The ball is placed arbitrarily between a flat and the measuring pin, and the diameter is measured. In order to guarantee that the measuring pin is vertically above the center of the ball we use two vertical flats with angle of 90° against which the ball is horizontally pressed during the measurement. By rotating the ball in various directions, the minimum and maximum diameters can then be determined. The difference between the two gives the lack of sphericity.

Bounce

~~The bounce is~~ is measured by releasing the ball mechanically without spin. After its bounce on a standard steel plate the ball is monitored with a digital camera with a calibrated mm scale in the background. The photos are evaluated. The geometric mean of three determinations then permits calculation of the maximum height of bounce of the "south pole" of the ball. A standard steel plate is made of Steel S235 with a surface roughness of $R_a \leq 1.0 \mu\text{m}$ and $R_{\text{max}} \leq 7.5 \mu\text{m}$. The size is no smaller than 20mm thick and 200 x 200 mm large.

Alternatively, the rebound height can be measured by other methods, which give the same results. Results from any optical method used must take into account a possible parallax error.

Veer

~~Veer is~~ is a criteria ~~measure~~ of the total sphericity of the ball, not merely its external aspect. ~~It is measured by rolling the ball~~ The ball is rolled down a slight incline onto a horizontal surface and measuring the distance by which it deviates from a straight line, the "centre line", as it rolls across the horizontal surface. The incline is 100mm long at 14 degree to the horizontal; on a table that is 100cm long this gives a rolling time of about 3 seconds. Each ball is measured three times. A negative result is reported if the ball fails the test twice. A "failure" is defined as the event that the ball is hitting one of the two "side lines" which run parallel to the centre line in a distance of 175mm to the left and 175mm to the right.

~~It is registered~~ We will register where a ball eventually hits the sideline measured from the starting point; $X_1 = 0 - 50 \text{ cm}$, $X_2 = 50 - 75 \text{ cm}$, $X_3 = 75 - 100 \text{ cm}$ and $o =$ ball does not hit the side line at all. ~~This is for collecting data for the future.~~

The rolling surface is at least 20mm thick with a roughness of $R_a \leq 1.0 \mu\text{m}$ and $R_z \leq 7.5 \mu\text{m}$.

For balls with seam: Rolling once ~~twice~~ on the seam, and twice ~~once~~ about an arbitrary axis.

For balls without seam: Balls are marked with an artificial seam according to Appendix E. Then rolling one time on red, blue and green lines.

Hardness

Is measured on a fully automated and computerized Zwick tester (or equivalent). ~~It uses~~ We use a preload of 0.5 N and testing starts 10 sec after preloading. A 20mm diameter pin presses against the ball with a 50 N force loaded at 10 mm/min, and the indentation is recorded with a precision of 0.01mm. The ball is supported by an annular ring whose upper inside surface slopes at an angle of 45 degrees. The outer diameter of the ring is 40mm and the inner diameter at the bottom of this slope is 20mm.

Measurements are made on each pole and once on the seam / red line (see Appendix E); the geometric

mean average for the poles provides a measure of the hardness, and the difference between that and the seam indentation is a measure of the lack of symmetry for hardness.

Colour

The ball colour is measured and calculated according to the CIE Lab system, giving three values ΔL , Δa and Δb (Δ = Greek letter "delta" meaning "difference"). These values show the differences compared to the Munsell color standards given below for white and orange. L indicates the black/white value on a scale from 0 to 100; "a" indicates the green/red value; and "b" the blue/yellow value, both on a scale from minus to plus 100. The measurements are performed on 3 points, one on the seam and two on other positions on the surface, of 4 balls randomly chosen from different boxes. If no seam is available three random points of measurement have to be taken. The device is a Spectrophotometer according to ISO 7724 (D65/10° incl. gloss) with a black velvet hemisphere behind the ball as background for the measurement. Supplier of Munsell Standards: X-Rite Inc., 4300 44th Street S.E., Grand Rapids, MI 49512 U.S.A.

Specifications

For the calculation of the following values two digits are taken into account.

B.1 Weight Conformity

Law 2.3.2 specifies 2.7g, but any weight between 2.67 and 2.77g is acceptable for any one ball. No more than 1 ball out of the 24 sampled may be outside this range. The sample mean must be between 2.69 and 2.76g. In carrying out statistical calculations we treat any weights less than 2.60g or greater than 2.85g as outliers.

B.2 Weight Regularity

The standard deviation may not exceed 0.03g.

B.3 Size Conformity

~~For celluloid balls:~~

~~The minimum diameter of every ball must be at least 39.50 mm, and its maximum diameter must not exceed 40.50 mm. The sample mean average diameter, i.e. the mean of the average of the maximum and minimum diameters for each ball, must be in the range 39.60-40.40 mm. Values below 39.25 mm or above 40.75 mm are considered in our calculations as outliers.~~

~~For non-celluloid balls:~~

~~The minimum diameter of every ball must be at least 40.00mm and its maximum diameter must not exceed 40.55mm 40.60mm. The sample mean average diameter, i.e. the mean of the average of the maximum and minimum diameters for each ball, must be in the range 40.00-40.40mm 40.50mm. Values below 39.70mm or above 40.75mm are considered in the our calculations as outliers.~~

B.4 Size Regularity

The standard deviation of the average diameter may not exceed 0.04mm 0.06mm.

B.5 Sphericity Conformity

~~For celluloid balls:~~

~~The sphericity of any ball must be less than 0.35mm, and the sample mean sphericity must be less than 0.25mm. (The sphericity of a ball—more correctly the lack of sphericity—is the absolute difference between its minimum and maximum diameters.) In our calculations values greater than 0.50mm are treated as outliers.~~

~~For non-celluloid balls:~~

The lack of sphericity of any ball must be less than 0.25mm, and the sample mean lack of sphericity

must be less than 0.18mm ~~0.20mm~~. (The ~~sphericity of a ball~~ ~~more correctly the~~ The lack of sphericity of a single ball is the absolute difference between its minimum and maximum diameters.) In the our calculations, values greater than 0.30mm are treated as outliers.

B.6 Sphericity Regularity

The standard deviation of lack of sphericity may not exceed 0.04mm. ~~must be less than 0.06mm~~.

B.7 Bounce Conformity

~~All 24 balls must rebound to a height of not less than 240mm and not more than 260mm when dropped from a height of 305mm on to a standard steel block.~~

~~For non-celluloid balls all~~ All 24 balls must rebound to a height of not less than 240mm and not more than 265mm when dropped from a height of 305mm to a standard steel block.

B.8 Bounce Regularity *(to be examined)*

There is no specification for this property. Dynamic tests will be investigated.

B.9 Veer

No more than two balls shall fail, i.e. deviate twice by more than 175mm from the centre line.

B.10 Hardness Conformity

For balls with seam:

The geometric mean pole hardness for any ball shall be in the range 0.68 – 0.81mm

The geometric mean pole hardness for the sample shall be in the range 0.69 – 0.81mm

The mean seam hardness for the sample shall be in the range 0.72 – 0.83mm

~~The within ball (uniformity) coefficient of variation of the measurements on each pole and once on the seam shall be no greater than 0.17mm~~

~~The sample mean within ball (uniformity) coefficient of variation shall be no greater than 0.08mm~~

Both within-ball hardness variations (difference of the measurements between pole 1 and seam as well as between pole 2 and seam) shall be no greater than 0.15mm.

The sample mean hardness variation (mean of the 24 geometric means of the 2 hardness variations per ball) shall be no greater than 0.08mm.

For balls without seam:

The geometric mean hardness for any ball shall be in the range 0.70 – 0.90mm

B.11 Hardness Regularity

~~The coefficient of variation shall be not greater than 0.06mm.~~

The standard deviation of hardness (of the 24 geometric means of the 2 poles) may not exceed 0.04mm.



B.12 Colour

The specifications for the L, a and b values according to the CIE Lab system are

for white balls: Standard reference: Munsell notation: N9.5/ M

$$-6 \leq \Delta a \leq +5$$

$$-12 \leq \Delta b \leq +5$$

$$-21 \leq \Delta L$$

for orange balls: Standard reference: Munsell notation: 7,5YR 8/10M

$$-15 \leq \Delta a \leq +10$$

$$-15 \leq \Delta b$$

$$-10 \leq \Delta L$$

The average of the 12 measured points (4 balls, 3 points each) has to meet these standards. Any decimals in the measurement are rounded as usual, for example $\Delta b = -12.4$ is acceptable for white balls, whereas -12.5 is not.

B.13 Material thickness

~~For non-celluloid balls:~~

Material thickness shall be measured using an ultrasonic device on the 6 measuring positions. This is done on the 5 samples which were worst in the veer test, and the 5 samples which were best. In a first step, this This is only for collection of information in order to further improve balls and methods.

B.14 Durability and friction

Tests for the durability of the ball and its friction against table surfaces and/or a standardized surface are currently being investigated ~~developed~~. Manufacturers shall be prepared that these tests will be included in the approval process in the future, after being described in detail in this Technical Leaflet.

C. Marking

If the grade of the ball is indicated by a numbering system, no number higher than 3 may be used, e.g. „Three Star“.

C.1 The Stamp

The compulsory stamp on the ball must include the following four components:

- The ITTF Approval, ~~This may be indicated~~ by the initials "ITTF" or by "ITTF approved", or by the ITTF logo.
- the trademark or brand name
- the inscription "Made in", followed by the country of production
- the inscription of "40+", indicating celluloid-free balls ~~either:~~
 - "40", or "40mm" for celluloid balls
 - "40+" for non-celluloid balls

The stamp on the ball may not include any other components.

The requirements of Section C.1 do not apply to the secondary stamp for specific events (see A.3).

If the production process is taking place in more than one country, the reference shall be to the main step of production. For example,

- if the ball is made of two halves which are produced in country A and put together in country B, the reference is country A

- if the raw material of the ball is originating from country A and any material processing is done in country B, then the reference is country B

Any case of doubt shall be brought before the ITTF ~~Equipment Manager~~ and will be decided by the ITTF

case by case.

The same text must appear on all balls of an approved brand. I.e. it is not permitted to put one country name on some balls and a different one on others with the same brand name. Wrong claims will be penalized with a fine and can lead to immediate withdrawal of the ITTF approval.

No other text is permitted. The stamp may cover an area no greater than 280mm² described by a circle or a rectangle with a maximum side length of 25mm circumscribing all letters and symbols. It may be printed in one or two colours, but the same colour or combination must be used for all balls of one brand. All inscriptions must be easily readable. The trademark or brand name should be the most pronounced inscription.

The ink of the second stamp may be the same as for the main stamp.

~~The requirements of Section C.1 do not apply to the secondary stamp for specific events (see A.3).~~

C.2 Trademark or Brand Name

The Approval of the ITTF, the country or the expression "made in" are not considered to be part of the trademark or the brand name. The trademark or brand name must be unique and may not be used for another type of ball, especially not for an unapproved one. All balls with the same trademark or the same brand name must have the same level of quality.

Also, a celluloid and a ~~non-celluloid-free~~ ball of the same supplier must not carry the same trademark or brand name, respectively. If the supplier wishes to brand his celluloid and ~~non-celluloid-free~~ balls as similar as possible, the minimum difference accepted is that the term "40+" is added to the brand of a celluloid ball to define the brand of a ~~non-celluloid-free~~ ball. For example, "Super Supplier – Mega Brand" and "Super Supplier – Mega Brand 40+" are an acceptable combination for the brand name.

With a brand name containing "40+", both requirements no. 2 and 3 of C.1 are considered as fulfilled. However, the "40+" then cannot just be used on the ball stamp, but must be used everywhere (packaging, sales channels, advertisements etc).

An ITTF approved ball may lose its approval if the supplier markets another non-ITTF-approved ball with the same or similar appearance as the ITTF approved one, with which it could be confused.

The ITTF will make its best effort to ensure that the trademark or brand name does not infringe on the already existing balls brands. The ITTF is not responsible for any illegal use of registered trademarks. Verifying the correct and legal use of trademarks is not part of the ITTF approval procedure.

C.3 Packaging

Each ball pack unit ~~The packaging~~ must have the same information as is on the stamp, however the ITTF logo is obligatory and shall be used as described in section C.5. In addition, the packaging may also include the name of the country where the company headquarters are registered and may have additional information such as technical data or national approvals. The wording used on the packing may not contain false claims.

C.4 Date Code

Each ball pack unit ~~All packagings (see A.4)~~, but not the ball itself, must be marked with a date code corresponding to the date of production (month / year). The date code must be readable without the need to destroy the packaging.

The date code consists of 4 characters: the first 2 for the month and the last 2 for the year. Month and year are encoded using the capital letters from A to I for the numbers 1 to 9 (A = 1; B = 2; etc. up to I = 9; X = 0).







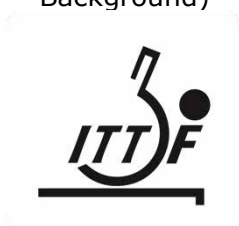

Examples: a) ABXC means 1203, which is decoded as December 2003.

b) XEAA means 0511, which is decoded as May 2011

This date code system, in latin characters, is mandatory for all ITTF approved ball brands.

Manufacturers are strongly encouraged to clarify the design of the stamp, the packaging and the date code before production with the ITTF Equipment Committee.
 A missing date code is penalized with a fine.

C.5 Guidelines for the use of the ITTF Logo on the ball and the packaging

THE STAMP	
<p>Recommended: LOGO 4 (Line Art Version: Black On White Background)</p> 	<p>The stamp on the ball must include the ITTF Approval as described above. This may be indicated by "ITTF", "ITTF approved", or by the ITTF logo.</p> <div style="display: flex; justify-content: space-around; align-items: center;">    </div> <p>When the ITTF logo is printed, it should:</p> <ul style="list-style-type: none"> • be in Black or Gray, but not in any other colours • not have text or shapes overlapping it, although the safety area is not mandatory for printing on balls <div style="display: flex; justify-content: space-around; align-items: center;"> ✗ Incorrect ✓ Correct </div> <div style="display: flex; justify-content: space-around; align-items: center; margin-top: 20px;">    </div>
THE PACKAGING	
<p>Recommended: LOGO 1 (3D Logo: Green On White Background)</p> 	<p>The ITTF Logo can also be printed on the packaging, but should adhere to the guidelines stated in the "ITTF Branding Guidelines v3.0".</p>

For more information, please refer to the ITTF Branding Guidelines v3.0: <http://bit.ly/2ybHNbw>



All versions needed, of the ITTF logo, can be found here: <http://tiny.cc/ittflogos>

D. Administrative Matters

D.1 Changes

Any change of the trademark, brand or the ball name, the date code, the stamp, the packaging, the ball quality, the source of supply and any other changes relevant for ITTF approval must be notified to the ITTF ~~Equipment Committee~~. If the stamp or box design is changed, two ball boxes must be sent to the address given on the ITTF.com or as instructed by the ITTF under "Equipment / Balls". The changes must be confirmed by the ITTF **in writing**.

The failure to announce changes to the ITTF will be penalized with a fine or can even lead to an end of the ITTF approval in cases of severe or repeated failures.

D.2 Publication

A list of all ITTF approved balls ~~brands~~ is published in the Internet. The approval list is published in alphabetical order by trademark or brand name.

D.3 Approval Code

The ITTF uses an approval code consisting of

- a serial number according to the date of application for ITTF approval and
- the month and year of application for approval.

Example: ITTF-21-B-06/00; meaning: 21st ITTF approved ball (B), approved in June 2000. The manufacturer is free to use the approval code in his advertisements.

E. Appendix – Marking balls without seam.

General:

Balls without seam must be equipped with artificial seams for testing. This is to obtain an even distribution of the measurements. ~~There would be no end in measuring if we should check every theoretical spot on the ball. Instead, we are trying to get some distributed data through a simpler procedure.~~

The sequence of testing is not important, apart from colour testing which should be made before the marking of lines / "seams".

Sequence:

1. Individual numbering of the received balls - beginning with no. 1 - in an arbitrary position.
2. Measuring colour on 3 independent spots.
3. Drawing an "equator" under the number with **red** ink.
4. Making a **blue** circumference 90° perpendicular on equator on the right side of the number.
5. Making a **green** circumference 90° perpendicular both on equator and on the **blue** line on the left side of the number.
6. ~~We will now have 6 measuring positions will be used;~~ i.e. 4 along the **red** equator where **blue** and **green** lines cross, and 1 on each pole ("**North**" is above the number and the equator and "**South**" is below); in addition to the 3 circumferences, i.e. the **red**, **blue** and **green** lines.
7. The balls are then ready for testing.
8. These designations have to be used in the reporting.

End of T3

Submitting body	ITTF EQUIPMENT COMMITTEE
------------------------	---------------------------------

Proposition: Modification of T4 "Racket coverings".

*The Equipment Committee decided during its meetings to refurbish T4 to a new T4 "Rackets" with the 4 sections: racket coverings, blades, assembling racket coverings and blades, other accessories. The task was not yet possible, but more-**administrative modifications are urgent in order to comply T4 with better new practice.** Here the changes proposed:*

Suppliers can submit new rubbers 4 times a year instead of 2. This may allow to abolish the time-consuming expedited procedure and offer an even better service to the suppliers. Rubbers withdrawn by the supplier will stay 6 months (instead of 3) on the list: this helps retailers to clear stocks and players to switch to another racket covering. The authorization of a rubber will be provisional until the final sample is submitted (in-between 6 months).

As for other equipment, the details of the authorization procedure will be published on ittf.com; presently, they will be provisionally added to an annex to T4. Principles, which guarantee continuity and transparency, stay in the leaflet.

Reduced fees will be charged for withdrawn rubbers, and for those, appearing first in LARC of October.

In order to simplify procedures, the EqC proposes that failure at a re-test ends in either the correction of the deficit or the deletion of the authorization, without involving the EC or the BoD. Sanctions resulting in suspension or deletion stay in the good hands of EC and BoD.

Bright colours actually are considered as a definition. We propose a separate point with explanations and a table including the requirements (*see specific proposition*)

RACKET COVERINGS

Modification of T4 (2020)

Modification 1 = Implementation of the EqC decisions of Budapest (new rubbers 4 times per year) and extension from 3 months to 6 months for withdrawn rubbers staying authorized

3. The List of Authorised Racket Coverings (LARC)

LARC is published four times per year. The publication dates are normally April 1st and October 1st. New racket coverings in LARC – marked as **bold** - are authorised from that day.

Racket coverings, which have been withdrawn by the supplier, will stay authorised for a 6 months period and they will be published together with LARC on its last page.

The authorised racket coverings ~~at any time~~ are those in the current version of the LARC or in the list of new rubbers, for the period specified in the header. The Internet version may be corrected for errors during the season. Information will be given on ITTF.com. ~~It is not permitted to use racket coverings outside the valid periods given in the LARC.~~

... no change on last 2 paragraphs ...

Modification 2 = Abolishment of the expedited procedure as new rubbers can now be admitted every 3 months.

2.3. Simplified-Expedited procedure **to be abolished on September 1st, 2022**

Modification 3: Provisional transfer of the details (*stroken through*) of the authorisation procedure to an annex to the leaflet; *later on, a more detailed procedure, including and adapting the existing instructions should be published by the EqC on the ITTF web site. This will make T4 shorter and better readable and will keep it technical (see attached annex). A provisional authorization will be void after 6 months if no final sample has been submitted.*

2. The detailed procedure of obtaining and maintaining authorisation

Detailed procedures for the authorisation presently can be found in an administrative annex to T4; they follow the principles as laid down in this technical leaflet. The instructions can be modified by the Equipment Committee, they are published on ittf.com and may be transferred to a document related to the approval policy of ITTF. A racket covering, which is listed or newly added on the LARC is authorised for the period given in the header.

2.1 General (last paragraph)

The samples that are submitted to the ITTF for testing are taken to be representative of the normal production, and the ITTF decisions are based on that. An authorization is provisional; it is void if the supplier has not submitted the final sample to ITTF in-between 6 months after the date of authorization.

2.1. Procedure – Principles (new shorter text)

1. A new supplier (or an existing supplier using a new brand name) shall submit the Supplier Information form available at ITTF.com. The ITTF will then issue a supplier number to the new supplier.
2. For each new or modified racket covering, the supplier should complete and submit Form R-A, which is available at ittf.com, together with the requested annexes.
3. All instructions at ITTF.com or given by the ITTF directly to the supplier have to be followed for the continuation of the authorisation procedure.
4. The racket covering samples, unless agreed otherwise, will be directed by the ITTF to a laboratory for testing. The supplier will be informed and given a reference number.
5. When submitting racket coverings for repeated tests or periodic re-test, paragraphs 1 and 2 above are not required.

(the practical instructions have been transferred to the annex to T4, please see last page)

Modification 4: FEE PAYMENT (to be adapted to the new delays for authorizations of new rubbers) and RE-TESTING.

2 Fees

~~There is a **A testing** fee, which must be paid before the results of any actual tests are communicated.~~ The testing fees are subject to changes year by year. The ITTF Equipment Coordinator may be contacted for information about testing fees. This is also the case for any extra tests made for suppliers and for the retesting of racket coverings ~~after a period of ten years. If more frequent testing is considered necessary by the Equipment Committee, the supplier will have to pay the fee.~~ The fees will be invoiced from the ITTF.

An **authorisation** fee is paid for being included in the LARC (on the paper version and on Internet, including the image files). Lack of payment will mean withdrawal from the next LARC.

The authorisation fees are paid for all racket coverings included in LARC, which are published in January or in April. In July and October, only the new racket coverings entering LARC for the first time after April are subject to a reduced fee per racket covering. A reduced authorisation fee has to be paid for the 6 months period after withdrawal has been announced.

~~When a new supplier is entering LARC in October for the first time, it is subject to the authorisation fee, half the amount for the first racket covering and full amount for each additional racket covering, according to the list of fees, and will be invoiced again in April next year.~~

The amount of the fees is determined by the Executive Committee taking prior advice from the Equipment Committee.

If a racket covering is removed from the LARC for technical or financial reasons, there will be no refund.

If a supplier desires to re-authorise a known racket covering that has been removed from the LARC for whatever reason, it will be treated as a new brand with new test and authorisation fees.

3 Re-testing of racket coverings

Racket coverings will be periodically re-tested, presently approximately every ten years, after having been included on the LARC. The suppliers will be notified to submit samples, and may be required to deliver ~~there is no~~ additional information. The test fee will be invoiced from the ITTF.

When comparing two rubbers of the same brand at different times – for instance when making a re-test, - the rubbers must be recognizably similar: for example in translucency, thickness, and pimple shape, spacing and dimensions. Rubbers which do not match will not be authorized as the same model.

In addition, retail samples of racket coverings may be inspected or re-tested at any time to verify continued compliance with these specifications. A failure at such testing or inspection may result in the immediate cancellation of the authorization of the racket covering and its deletion from LARC; the supplier will be asked to submit comments before the pre-mentioned action may be taken.

(Provisional annex with practical instructions, see next page)

(Bright colours please see additional proposition)

Administrative annex to T4: additional practical instructions for the authorization procedure

From paragraph 2.2.2

An image with dimensions (in JPG format) of the branding area of the new racket covering should accompany each Form R-A, for ITTF verification prior to mould fabrication. A black and white version is recommended. Please follow the guidelines in section C of this technical leaflet and on ITTF.com.

From paragraph 2.2.3

The supplier should submit the following to the address given under "Contact Person" on the ITTF web site ITTF.com:

- One top sheet sample of each colour – without sponge.
- One red racket covering for each available sponge colour, with the thickest available sponge, in plastic retail packaging.
- One black racket covering with the thickest available sponge in any colour, in plastic retail packaging.
- For pimples-out, one additional sample without sponge in red. Pimples-out racket coverings are subject to a friction test which may take additional time and will be invoiced additionally. This extra sample is intended to save time.
- If a special version will be sold without sponge and equipped with a textile or other reinforcement, a sample of this should also be submitted.

These will be [ITTF's](#) reference samples for all tests. Please ensure that all charges are paid before shipment.

Entire paragraphs 2.2.4, 2.2.6, 2.2.7 and 2.2.8 (they will re-numbered)

(4.) Ship the samples, free of any charge and declared as "sample for inspection, no commercial value". If a value must be stated, do not set it to more than \$20, or less than \$1 on the paperwork which follows. If any additional costs must be paid, which is rare, the supplier will be charged.

(6.) A testing fee invoice carrying the reference number will be sent from the ITTF to the supplier. Each new required test will generate a new fee invoice.

(7.) The supplier will be informed about the result when the test results are available, provided the test fee has been paid.

(8.) After the racket covering has passed all tests and the testing fees are paid, the racket covering will be included in the next issue of the LARC. A fee per year will be invoiced from the ITTF.

... to be completed

Modification of T4 – Colours of racket coverings (Annex 5)

Submitting body ITTF EQUIPMENT COMMITTEE

Proposition (text see annex): **Modification of T4 "Racket coverings" – the colours of the racket coverings**

The Equipment Committee proposes to change the related "Definition" into a new section "Bright colours for the racket coverings". A table of permitted colour domains, their lightness and their saturation has been established. Taking into account that later it may be easier to open the colour ranges than to exclude undesirable colour tones, the Equipment Committee stays rather restrictive. The modern scientific colour system used is CIE-LCH. The section explains the criteria of the choices, and admits visual inspection for limit cases.

N.B. The AGM 2019 decided the implementation in 2021. A final date will be proposed to and decided by the BoD.

Under Definitions delete:

~~"Bright red" ([The Law 2.4.6](#)) is defined on the Munsell system by three co-ordinates:~~

~~— Hue: — 4.0 — 6.5 R~~

~~— Value: — min. — 3.1~~

~~— Chroma: — min. — 7.5~~

~~Colours for red top sheets are measured on a white background, as complete racket coverings, with all colours of sponges the racket covering will be sold with. Red top sheets alone will be measured only upon the supplier's request; ref. Konica no.1864-721 (CM-A101W).~~

Create a new paragraph after Definitions:

Bright colours for the racket coverings

The choice of the permitted bright colours shall be guided by the following 2 considerations:

- A player shall be enabled to early and safely detect, which racket side will hit the ball: the colour of the second racket covering shall be easily distinguishable from black, also in a shaded position.
- A player shall be enabled to safely see the exact moment of the impact of the ball on the racket covering: the colour of the racket covering shall permit this observation at any angle under strong light conditions.

Modification of T4 – Colours of racket coverings (Annex 5)

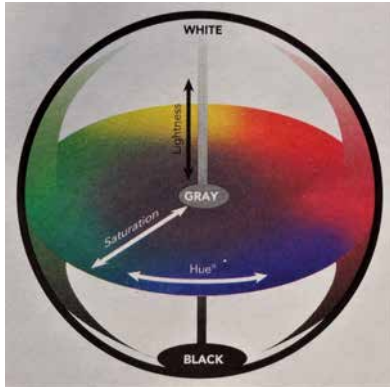

Permitted bright colours are defined on the CIE-LCH system by 3 coordinates:

L = Lightness from darkest (0) to lightest (100),
 C = Chroma/saturation from centre (0) to outside (up to 100),
 H = Hue/colour, expressed in degrees: 0° (red), 90° (yellow), 180° (green), 270° (blue) up to (360° red).

The table below delimits the acceptable ranges of bright red, green, blue, violet and purple/pink.

Colours	Colour coordinates	Hue H	Chroma C	Lightness L
BRIGHT RED	R	18°-31°	> 37	35 - 72
BRIGHT GREEN	G	103°-185°	> 37	50 - 72
BRIGHT BLUE	B	218°-264°	> 32	50 - 72
BRIGHT VIOLET	V	300°-325°	> 32	50 - 72
BRIGHT PURPLE/PINK	P	350°-360° & 0°-16°	> 32	45 - 72

Colour tones, whose colour coordinate hue, chroma or lightness is in between ± 1 to the acceptable minimum or maximum are considered as a limit case.

If the value measured is outside the acceptable range, it is called a tolerance.

A visual inspection under strong light and under shade conditions of a "limit" racket covering, will decide if it gets a provisional authorization or if it will not be authorized; a provisional authorization may be revoked by the ITTF in case of complaints.

The following criteria shall be applied for the decisions about limit cases:

Number of limit coordinates		Provisional authorization based on visual inspection
Total	Tolerances among Total	
3	0, 1, 2 or 3	No authorization
2	0	Authorization possible
2	1 or 2	No authorization
1	0	Authorization
1	1	Authorization possible

A racket covering, whose colour coordinates are inside the acceptable range, but is not seen fulfilling the requirements of "distinguishability", may also not be authorized.

The tolerance given includes the normal differences between the testing devices; values measured are rounded down or up to the nearest unit.

Resolutions to the 2020 ITTF BoD

Resolution H

(Simple majority required)

Proposed by the Swedish Table Tennis Association

The ITTF to take the lead in finding a suitable working model pushing for a unified – globally accepted sanctioning system for all professional leagues in which players can earn their living.

The PLSS should govern the international exchange of players based on national associations approval (playing permit) and set up for a better control of the calendar dates involved, including a world-wide National Association Protected Dates Model (NAPD) (allowing for the NA:s to schedule and work respective national team programs on specific, protected dates cleared by the ITTF and synced with the continental bodies)

Rationale:

We are currently experiencing the rapid growth of a number of Pro level league initiatives (T2, T-league, ITTL, Challenge series etc) partly operating outside national associations control/ sanction. It is time to develop a working model in which national associations clearly can follow the process in a productive manner. We believe that the ITTF needs to properly register and openly sanction all pro level leagues in order to control and secure the calendar (NAPD), the international exchange of players, as well as to sure up the rights and duties of national associations, including its players in the process.

Resolution I

(Simple majority required)

Proposed by the Swedish Table Tennis Association

The ITTF to introduce **Member Association Protected Dates** covering all ITTF Tour level events, all professional leagues sanctioned by national associations, as well as **professional league competitions** operated by external bodies/organisations sanctioned by the ITTF. The NAPD model requires any NA's or registered –sanctioned pro league to secure a blank calendar of 10 days (championships opening day -10days) for National Associations preparation prior to any championships on continental and world level.

Rationale:

In order to secure a better process in building the international calendar the ITTF needs to secure certain dates for Member Associations Programs prior to World and Continental championships. Such a process should also include any professional league sanctioned by national associations as well as any other external organising bodies approved by NA's or the ITTF

Resolutions to the 2020 ITTF BoD

Resolution J

(Simple majority required)

Proposed by the Swedish Table Tennis Association

To request the BoD to study methods to enhance the recognition and to ensure the coaches have in the ITTF competitions the importance they should, as currently, coaches are not entitled to any free hospitality in ITTF Competitions other than the World Junior Championships. Ideally, the ITTF should have an International Coach Registry, and only coaches certified can seat on the bench in ITTF Major Events. This is important if we want the technical level around the world to raise, especially in those countries with a weaker Association structure.

Rationale:

To ensure Coaches are better valued in the ITTF and more resources are oriented to their participation and education.

Resolution K

(Simple majority required)

Proposed by the Swedish Table Tennis Association

The Future Events Working Group to explore the feasibility to organize in the future World Mixed Team Championships regularly.

Rationale:

To introduce a new world title competition for national teams and to introduce mixed teams into the competition system, inspiring the ITTF to develop an innovative, fast-format, TV friendly, team match system using the new scoring by accumulative games approach (potentially timed), for the mixed teams competition to become unique and exciting.

Resolution L

(Simple majority required)

Proposed by the Brazilian Table Tennis Association

To create a criterion to measure the friction of the table, in a scale from 1 to 10 (more or less than it), that show the smoother to the rougher one.

Rationale:

The equipment requirements that certificate official tables do not bring a scale of friction of the table, that we consider an important standard to be analysed because of its influence in the speed and effect of the ball.
